



SmartGen
ideas for power

**HWP SERIES
(HWP40/ HWP60/ HWP90/ HWP120)
FORCED CIRCULATION HEATER
USER MANUAL**



SMARTGEN (ZHENGZHOU) TECHNOLOGY CO., LTD.



Chinese trademark

SmartGen English trademark

SmartGen — make your generator *smart*

SmartGen Technology Co., Ltd.

No.28 Jinsuo Road

Zhengzhou

Henan Province

P. R. China

Tel: 0086-371-67988888/67981888

0086-371-67991553/67992951

0086-371-67981000(overseas)

Fax: 0086-371-67992952

Web: www.smartgen.com.cn

www.smartgen.cn

Email: sales@smartgen.cn

All rights reserved. No part of this publication may be reproduced in any material form (including photocopying or storing in any medium by electronic means or other) without the written permission of the copyright holder.

Applications for the copyright holder's written permission to reproduce any part of this publication should be addressed to SmartGen Technology at the address above.

Any reference to trademarked product names used within this publication is owned by their respective companies.

SmartGen Technology reserves the right to change the contents of this document without prior notice.

Table 1 - Software Version

Date	Version	Note
2014-07-08	1.0	Original release.
2015-04-10	1.1	Add types HWP60, HWP90, HWP120, remove type HWP30.
2016-01-22	1.2	DC pump has been updated to AC pump.
2016-07-12	1.3	Modify relay expansion board type.
2017-11-11	1.4	Modify relay expansion board & wiring connection diagram, and add AC contactor.
2018-03-22	1.5	Modify wire connection diagram.



CONTENT

1. OVERVIEW.....	4
2. PERFORMANCE AND CHARACTERISTICS.....	4
3. SPECIFICATION.....	5
4. HEATER INSTALLATION.....	6
5. OPERATING INSTRUCTIONS	7
5.1. PANEL AND BUTTON	7
5.2. DISPLAY DESCRIPTION	7
5.3. PANEL DESCRIPTION.....	7
5.4. OPERATION DESCRIPTION	8
6. USE AND MAINTENANCE	9
7. CONNECTIONS	10
8. CASE AND DIMENSIONS.....	11

SmartGen

1. OVERVIEW

HWP series forced circulation water engine heater is composed of 3 parts (control section, water pump and water heater).

If during cranking the outside temperature is lower than 4°C, engine coolant and lubricant may condense into solid state and lose their lubricating and cooling properties, which can damage the engine. Thus engine heater should be installed to ensure normal starting and running of the engine when the outside temperature is lower than 4 °C.

HWP series forced circulation water engine heater combines the following features: cast stainless steel inner pipes and end closure with high corrosion resistance; heating and overheat light indicators; user-defined thermostat set point; dry heating and overheat protection.

This product is suitable for various engine with (15~100) L displacement.

Please login our company's official website (www.smartgen.cn) to select heaters.

2. PERFORMANCE AND CHARACTERISTICS

- The circulating water pump adopts special customized pump with stainless steel pump head.
- Control section: microprocessor design; PT100 temperature sampling. Coolant temperature can be set via the control panel. Four digital LED display, current coolant temperature and all kinds of set point temperature can be displayed clearly.
- Dry heating and overheat protection due to the inner overheating temperature detect switch.
- Separately control of water pump and water heater: power on the water pump and water heater synchronously, once the set temperature has reached, water heater will be powered off firstly, after 60s, following is water pump. The goal is to prevent heat concentration and significantly prolong water pump lifetime.
- Manual test: test the water heater and water pump are normal or not via panel button.
- Fine cast aluminum enclosure;
- Stainless steel inner pipes and sealed end closure;
- There is a water drain valve with seal ring on the bottom of the heater so as to be used when needed;
- There is one-way inlet valve on the water inlet.
- This product can work normally at -25°C temperature.

3. SPECIFICATION

Table 2 – Parameters Specification

Type	HWP40	HWP60	HWP90	HWP120
Rated Power	4000W	6000W	9000W	12000W
Rated Voltage	AC 240V			
Rated Current	16.7A	8.3A	12.5A	16.7A
Phase	Single phase			
Engine Displacement (L)	15~30	25~50	50~75	75~100
Thermostat Range	Off: (5~99)°C On: (0~94)°C			
Default Thermostat Range	Off: (40±2)°C On: (25±2)°C			
Overheating Thermostat Range	Off: (95±3)°C On: (80±6)°C			
Insulating Resistance	≥50MΩ			
Electrical Strength	AC 1.5kV 1min			
Inlet/Outlet Size	3/4"(Φ19.5mm)			
Max. Water Pressure	0.5MPa			
Pump Flow Velocity	40L/min (1.5m of lift)			
Protection Level	IP44			
Vibration Resistance	(5~8)Hz Amplitude±7.5mm Triaxial (8~500)Hz a=2g Triaxial			
Shock Resistance	Half-sine Wave; a _{peak} =50g; Triaxial			
Working Conditions	-25 °C~+70 °C			
Storage Conditions	-30 °C~+70 °C			
Case Dimensions	444 mm×270 mm×380 mm			
Weight	14kg			

4. HEATER INSTALLATION

Please install the heater vertically according to the diagram before use. Pay attention to the direction of heater inlet and outlet, and ensure that the heater position is below the lowest water level of the engine and that all the air is exhausted out of the heater and it is topped off with coolant.

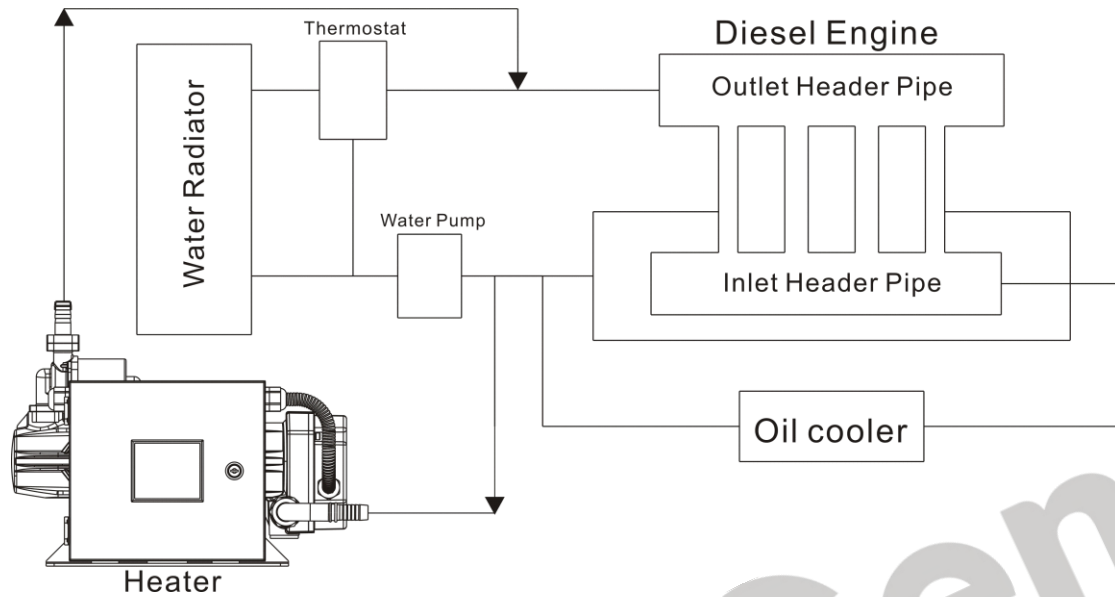

Fig.1 - Installation Plane Schematic

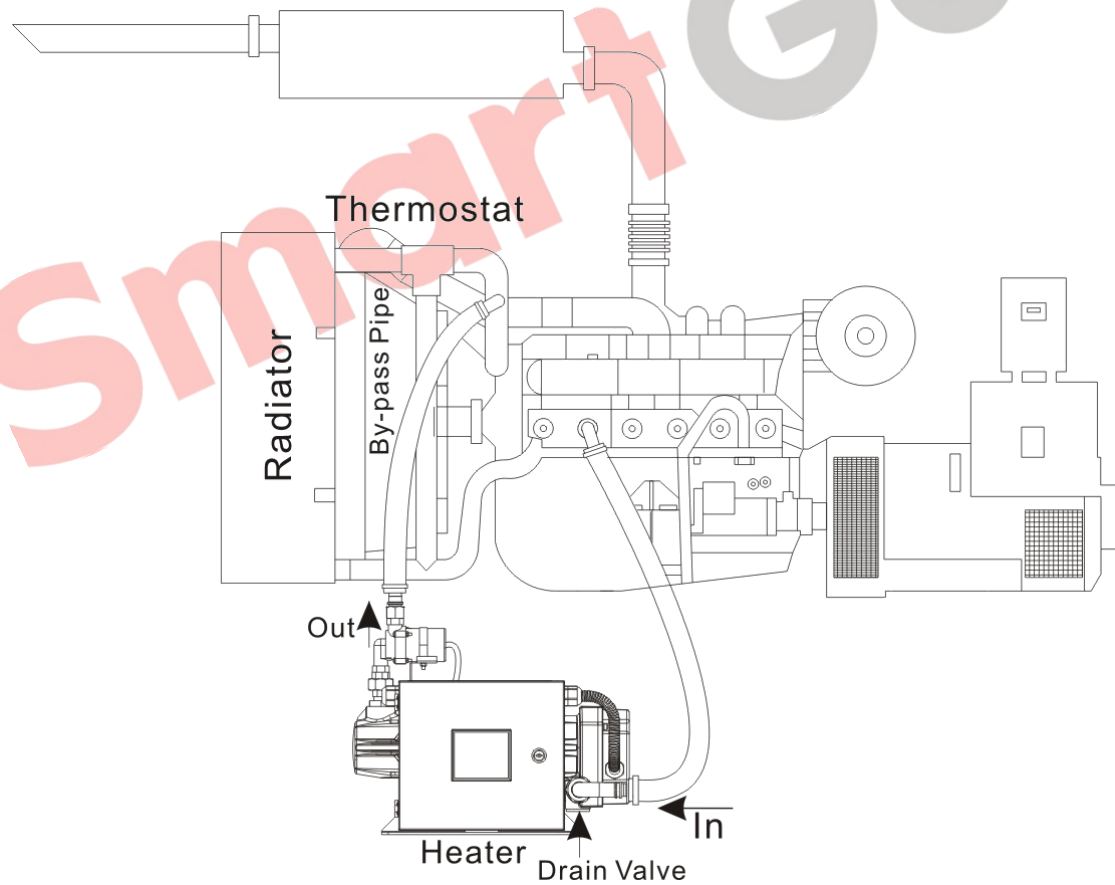





Fig.2 - Installation Side Schematic

5. OPERATING INSTRUCTIONS

5.1. PANEL AND BUTTON

Table 3 – Panel Display and Buttons

Button	Definition	Description
	Test	Pressing this button will test-run the machine.
	Lamp Test	All indicators will be illuminated when the button is pressed.
	Set	Using this button you can set the temperature value.
	Turn Page	Using this button you can scroll pages of the LED Nixie Tube; and adjust the value.

5.2. DISPLAY DESCRIPTION

The heater is heating on when the “Heating” indicator is illuminated while the Thermostat is open and the heater stops heating when the “Overheat” indicator is flashing.

Temp. Display: OFF

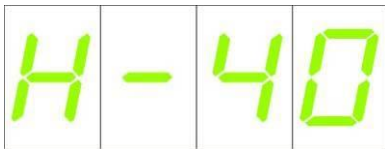

Temp. Display: ON

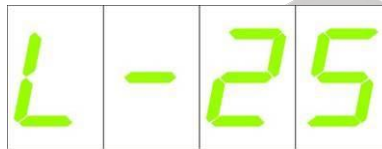

Temp. Display: Current Temp.



Alarm: Sensor Abnormal



5.3. PANEL DESCRIPTION

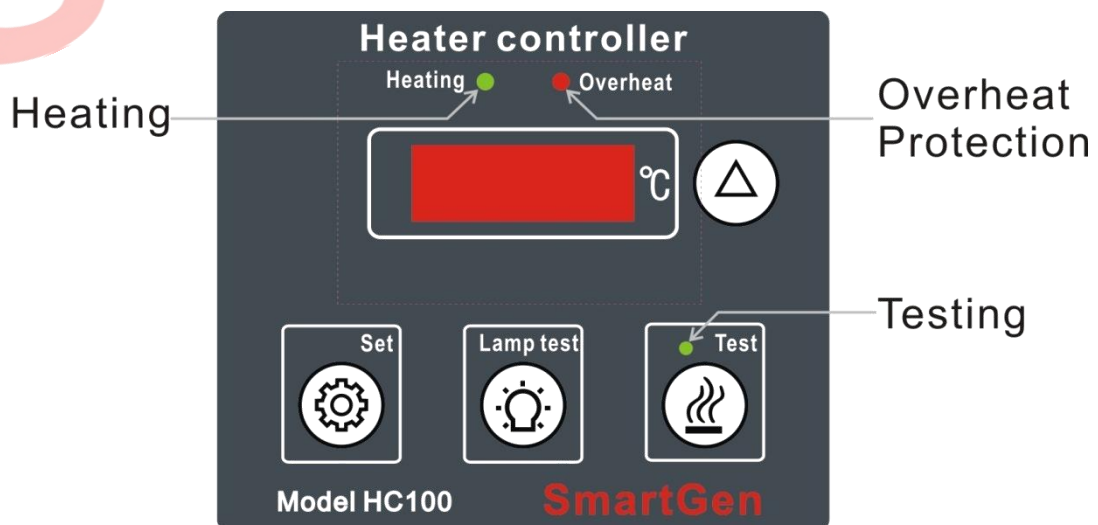

Fig.3 – Operation Panel Drawing

5.4. OPERATION DESCRIPTION

★Turn Page()

Using this button you can scroll pages of the LED Nixie Tube and adjust the value.







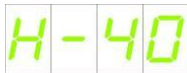

★Test()

If the water temperature has exceeded the preset “ON” temperature, pressing this button will test-run the heater, after 3s, it turns into Auto mode automatically.

★Lamp Test()

All indicators will be illuminated when the button is pressed.

★Set()

Pressing this button will enter into setting interface, as shown:  (Letter “H” means that it is the preset “OFF” temperature, here we take 40°C as example), the first digital is flashing and you can adjust it by pressing  button. Then press  button, the second digital will flash and the adjust way is same as the first digital. Press , as shown:  (Letter “L” means that it is the preset “ON” temperature, here we take 25°C as example), the first digital is flashing and you can adjust it by pressing  button. Then press  button, the second digital will flash and the adjusting way is same as the first digital. After doing these, press  button, the LED will back the current temperature. All the adjustment should be saved and not lost even when power is off.

6. USE AND MAINTENANCE

Before starting the machine, ensure that all the air is exhausted out of the heater and it is topped off with coolant, and make sure that the pump is full of water by using vent valve.



Fig.4 – Vent Valve Indicating Diagram

If water is used, please drain it off when generator is stopped to avoid internal corrosion. Otherwise, the remaining water freezes when temperature is lower than 0°C, which can damage the enclosure.

Corresponding antifreeze is strongly recommended.

Earth line must be soundly connected to earth.

Drain valve: Can be opened or closed using hexagonal tools.

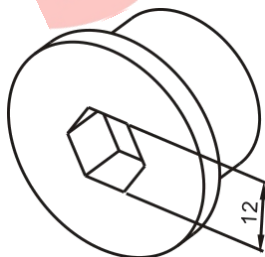

7. CONNECTIONS

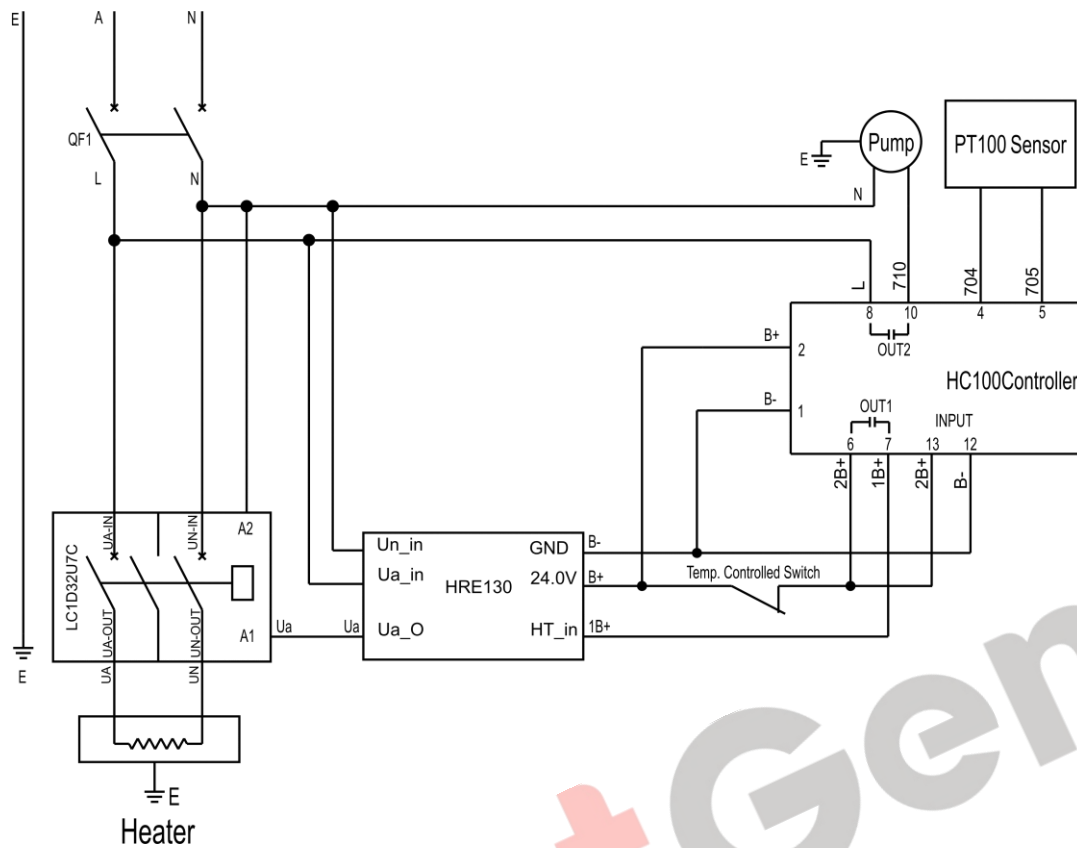

Fig.5 - HWP40 Diagram

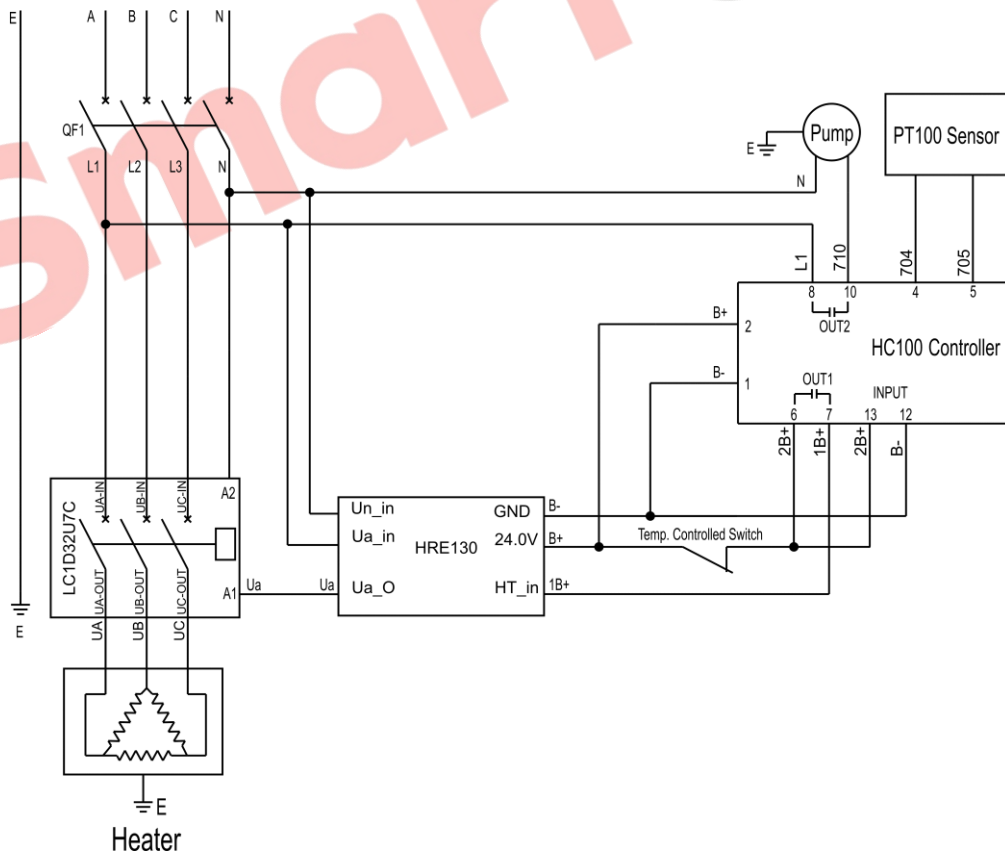

Fig.6 - HWP60, HWP90, HWP120 Diagram

Use 4mm² power line for tie-in. Earth line must be soundly connected to earth.



8. CASE AND DIMENSIONS

unit: mm

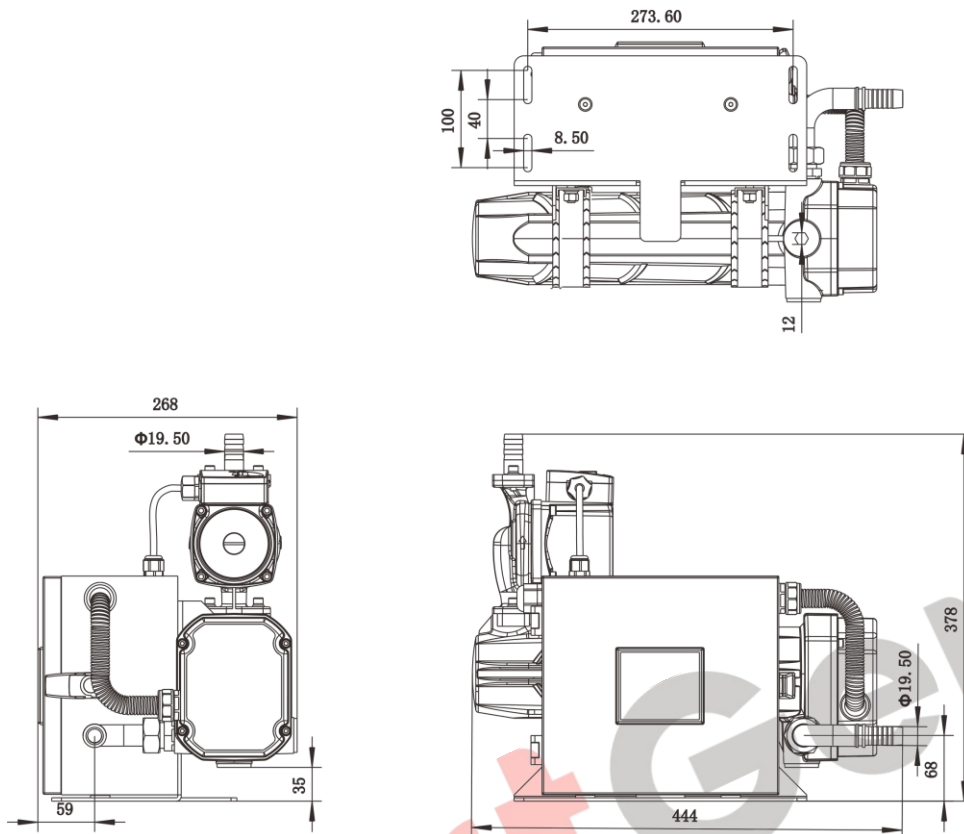

Fig.7 – Overall Dimensions

▲ **Note:** all the inlets/outlets connectors are Pagoda-shape.