



SmartGen
ideas for power

MGC120 PETROL GENSET CONTROLLER USER MANUAL



SMARTGEN (ZHENGZHOU) TECHNOLOGY CO., LTD.



Chinese trademark

SmartGen English trademark

SmartGen — make your generator *smart*

SmartGen Technology Co., Ltd.

No.28 Jinsuo Road

Zhengzhou

Henan Province

P. R. China

Tel: 0086-371-67988888/67981888

0086-371-67991553/67992951

0086-371-67981000(overseas)

Fax: 0086-371-67992952

Web: www.smartgen.com.cn

www.smartgen.cn

Email: sales@smartgen.cn

All rights reserved. No part of this publication may be reproduced in any material form (including photocopying or storing in any medium by electronic means or other) without the written permission of the copyright holder.

Applications for the copyright holder's written permission to reproduce any part of this publication should be addressed to SmartGen Technology at the address above.

Any reference to trademarked product names used within this publication is owned by their respective companies.

SmartGen Technology reserves the right to change the contents of this document without prior notice.

Version History

Date	Version	Content
2017-11-07	1.0	Original release;
2019-02-22	1.2	Fixed the logic description for air flap control; Fixed the default value for stepping motor as 250Hz; Fixed the stepping motor wirings in typical application diagram and add notes for it.

CONTENT

1 OVERVIEW	4
2 PERFORMANCE AND CHARACTERS	4
3 SPECIFICATION	5
4 OPERATION.....	6
4.1 CONTROL PANEL.....	6
4.2 INDICATOR DESCRIPTION	6
4.3 PUSH BUTTONS.....	7
4.4 AUTO START/STOP OPERATION.....	7
4.5 MANUAL START/STOP OPERATION	8
4.6 AIR FLAP CONTROL	8
4.7 ATS SWITCHING CONTROL.....	8
5 PROTECTION	9
6 CONNECTION	10
7 DEFINITION AND RANGE OF PARAMETERS.....	11
7.1 PARAMETER SETTING CONTENTS AND RANGE	11
7.2 PROGRAMMABLE OUTPUT DEFINABLE CONTENTS.....	14
7.3 PROGRAMMABLE INPUT DEGINED CONTENTS	14
8 CONTROLLER FUNCTION SETTINGS.....	15
9 COMMISSIONING	16
10 TYPICAL APPLICATION	17
11 INSTALLATION.....	19
11.1 FIXING CLIPS.....	19
11.2 OVERALL AND CUTOUT DIMENSIONS.....	19
12 FAULT FINDING.....	20

1 OVERVIEW

MGC120 Petrol Genset Controller belongs to AMF module, which is suit for single petrol genset automation and monitoring control. It can realize auto start/stop genset, alarm protection and ATS switching control functions by data measuring. The controller applies LED display and button-press operation. Most parameters can be adjusted from the front pannel of the controller and all parameters can be changed by PC software via LINK port. With simple operation, reliable performance, and compact structure and convenient installation advantages it can be widely used in various automation system for petrol genset.

2 PERFORMANCE AND CHARACTERS

- Able to collect single phase voltage of Mains and generator, which is suitable for 50Hz/60Hz AC system;
- Switchable display parameters:
 - Mains voltage (V)
 - Generator voltage (V)
 - Engine cylinder temperature (°C)
 - Generator frequency (Hz)
 - Battery voltage (V)
 - Accumulated running time(H)
- Equipped with Mains electricity monitoring function and AMF function;
- Protection function for generator under/over volt, under/over frequency, low oil pressure, and start failure protection functions; when they occur, LED indicates alarm types, and controller conducts shutdown protection;
- Using stepper motor and programmable outputs to control air flap;
- Speed signals derive from ignition coil primary (diode needs to be in series);
- Able to choose from three crank disconnection conditions (generator frequency, speed, and speed + gen frequency);
- Equipped with 2 digital inputs with defaults: remote start input and low oil pressure input;
- Equipped with 3 stationary relay outputs (fuel output, start output and ignition control);
- Equipped with 2 programmable transistor outputs, which can be set as common alarm output, ETS control, idle speed control, preheating control, GCB close output, MCB close output and air flap blocking output;
- Equipped with LINK communication port (SmartGen SG72 adapter applied): it is able to realize controller parameter settings, remote monitoring control and firmware upgrade functions.
- Digital tube and LED display with button-press operation;
- Silicone panel and buttons with higher ability to adapt to extremely high/low temperature;
- Screen protection adopts hard screen acrylic material;
- Modular structure design, anti-flaming ABS plastic housing, embedded installation way; compact structure and easy installation;

3 SPECIFICATION

Table 2 Technical Parameters

Items	Contents
Working Voltage	Suitable for DC12V power supply system;
Overall Consumption	Regular working:<2W (stepper motor is excluded) Standby mode:<0.5W
AC Volt Input:	
Mains Single Phase	AC 30V - AC 360V (ph-N)
Generator Single Phase	AC 30V - AC 360V (ph-N)
Alternator Frequency	50Hz/60Hz
Starter Relay Output	10A DC30V DC B+ supply output
Fuel Relay Output	10A DC30V DC B+ supply output
Ignition Relay Output	10A DC30V DC B- supply output
Flexible Transistor Output	1A connecting with DC B+ supply output
Stepper Motor Recommended	24BYJ48-12V (stepper angle 5.625° reduction ratio 16:1)
Overall Dimensions	95mm x 86mm x 46.5mm
Panel Cutout	78mm x 66mm
Working Condition	Temperature: (-25~+70)°C Humidity: (20~93)%RH
Storage Condition	Temperature: (-25~+70)°C
Protection Level	Front panel IP55
Insulation	Apply AC2.2kV voltage between high voltage terminal and low voltage terminal and the leakage current is not more than 3mA within 1min.
Weight	0.15kg

4 OPERATION

4.1 CONTROL PANEL

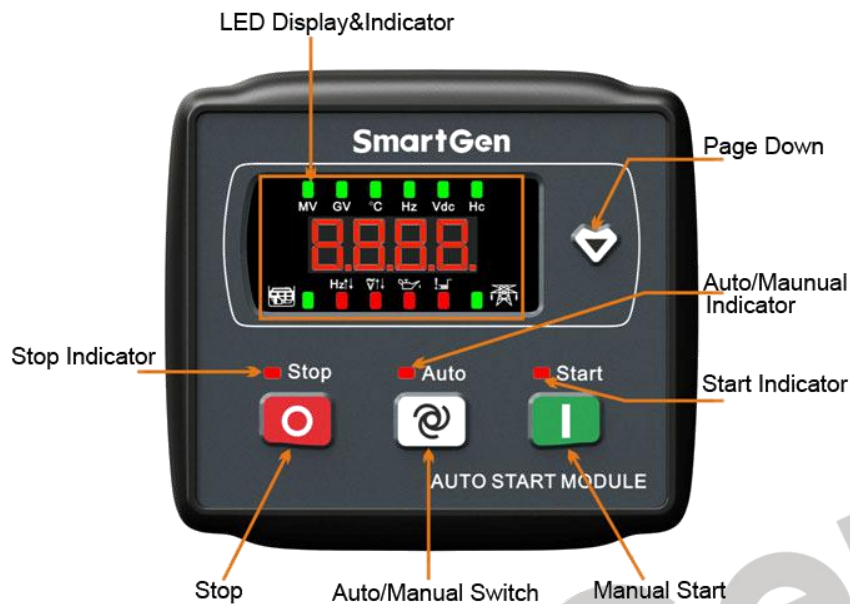

Fig. 1 Front Panel Description

Start indicator: it is always light from genset start to normal running, and in other status, the indicator will extinguish.

Stop indicator: it flashes when genset enters stop procedure; it is always light in the process of stop and in other status the indicator will extinguish.

4.2 INDICATOR DESCRIPTION

Table 3 Indicator Description





Icon	Definition	Icon	Definition
	Mains voltage indication		Generator under/over frequency alarm shutdown
	Generator voltage indication		Generator under/over voltage alarm shutdown
	Engine cylinder temperature indication		Low oil pressure alarm shutdown
	Generator frequency indication		Start failure
	Battery voltage indication		Generator indication
	Total running time indication		Mains indication

Notes:

- (1) Generator indicator: light-on when generator is normal running; flash when generator is abnormal; light-off when generator is unavailable;
- (2) Mains indicator: light-on when mains is normal; flash when mains is abnormal; light-off when mains is unavailable.

4.3 PUSH BUTTONS

Table 4 Button Description

Icons	Function	Description
	Stop/Reset	<p>Stop the running genset both in manual mode and in auto mode, and change controller to the manual mode.</p> <p>In stop process, re-press this button to stop generator immediately.</p> <p>In alarm status, press this button to reset any shutdown alarms.</p> <p>In stop mode, press this button for more than 3s to test if the digital tube and LED indicators are OK.</p> <p>In parameter setting process, press this button to exit the setting.</p>
	Auto/Manual Switch Increased value	<p>Press this key, if auto indicator lights on, controller is in auto mode; if auto indicator lights off, controller is in manual mode.</p> <p>In parameter setting, press this key to downturn or increase the values.</p>
	Start Decreased value	<p>In manual mode, press this key to start genset.</p> <p>In parameter setting, press this key to upturn or decrease the values.</p>
	Page Down	<p>Changeover the display contents of digital tube.</p> <p>Enter the parameter setting by pressing it for more than 3 second;</p> <p>In parameter setting, it confirms the set information.</p>

4.4 AUTO START/STOP OPERATION

Press  key and the indicator besides lights on, which means generator is in auto mode.

a) Auto Start Sequence

- 1) When remote start signal is active or mains failure(over/under voltage) delay is expired, "Start Delay" time is initiated;
- 2) When start delay is over, preheating relay outputs (if configured), "preheat delay" is initiated;
- 3) After the above delay, the fuel relay outputs, and one second later, the start relay outputs; During the starting time if the genset fails to start, fuel relay and start relay stop outputting, enter "Crank Rest Time" and wait for next start;
- 4) If the genset fails to start during the set starting attempts, LED indicator will display start failure;
- 5) If the genset starts successfully during the starting attempts, it enters "Safety On" time, during which low oil alarm types are inactive; After "Safety On" time, it enters "Start Idle Delay" (if configured);
- 6) During "Start Idle Delay", under frequency and under volt alarms are inhibited; When this delay is over, "Warming Up Delay" is initiated (if configured);
- 7) After the "warming up delay", genset will enter into Normal Running status. If genset voltage or frequency is abnormal, controller alarm shutdown will be initiated.

b) Auto Stop Sequence



- 1) When remote start input is invalid or mains normal delay is expired, "Stop Delay" time is initiated;
- 2) Once this "stop delay" has expired, the "Cooling Down Delay" is then initiated;
- 3) When "Stop Idle Delay" (if configured) starts, idle speed relay outputs;
- 4) When "ETS Solenoid Hold" begins, ignition control relay is energized and fuel relay is de-energized; Genset enters standby status.

 **Note:**

- 1) Press stop key in auto start status, generator will stop and enter into manual mode simultaneously.
- 2) Total running timer starts when generator meets crank disconnection conditions, meanwhile, the last decimal point of the digital tube flashes to indicate that the generator is running.

4.5 MANUAL START/STOP OPERATION

Press  key, indicator besides lights off, which means generator is in manual mode.

- a) Manual start:** press  button to start genset (Please refer to 4.4,a),2~7). If low oil pressure and abnormal voltage occur during the running process, controller shall protect it to stop quickly.
- b) Manual Stop:** press  button and it can stop the running genset (Please refer to Stop Sequence 2-4).

4.6 AIR FLAP CONTROL

- Engine cylinder temperature sensor is applied:
 - Before the genset starts up, If the cylinder temperature is below the set cylinder temperature limit of air flap blocking, the air flap is at the position of full blocking; if it is between the temperature limits of air flap dropping and air flap opening, then the air flap is at the position of half opening; if it is above the temperature limit of air flap opening, the air flap shall be at the position of full opening;
 - In the cranking process when the starting countdown goes more than half, the air flap opens 1/3 at current position; when start delay is finished but starting is not completed, next pre-start cylinder temperature estimation starts;
 - After successful start, the air flap opens 1/3 again at present position; when the cylinder temperature is over the temperature limit of air flap opening, the air flap shall open completely;
- Engine cylinder temperature sensor is applied, or sensor is opened circuit:

Before genset starts up, air flap is at the position of full blocking. For the first starting attempt, the air flap opens from full blocking and it shall open completely in 2s; for the second starting attempt, the air flap opens from the position of half blocking and in 2s it opens completely; if the two attempts both failed, the opening time for air flap becomes 10s.

After successful start, air flap opens 1/3 at present position and meanwhile after air flap blocking delay the air flap opens completely.

4.7 ATS SWITCHING CONTROL

Auto mode: if Mains is available, ATS switches it to Mains; if Mains is abnormal and genset is running normally, ATS switches it to generator. In other status, ATS lies at the Mains position.

Manual mode: if generator close input is active, then when genset is running normally, the generator breaker shall be closed; if generator close input is inactive or the generator is not running normally, then the Mains breaker shall be closed.

 **Note:** To use ATS control function, the programmable output ports shall be configured as GCB close output and MCB close output, and meanwhile input port shall be configured as GCB close input.

5 PROTECTION

- 1) Generator overvoltage shutdown: alarm occurs when the controller detects generator voltage exceeds overvoltage limit and the duration exceeds the generator abnormal delay value.
- 2) Generator under voltage shutdown: the controller detects after genset normal running and when generator voltage is below under voltage limit and the duration exceeds the generator abnormal delay value alarm occurs.
- 3) Generator over frequency shutdown: alarm and shutdown occur when generator frequency is above over frequency limit and duration exceeds over frequency shutdown delay.
- 4) Generator under frequency shutdown: the controller detects after generator-set normal running and alarm and shutdown occur when generator frequency is below under frequency limit and duration exceeds under frequency shutdown delay.
- 5) Low oil pressure input shutdown: the controller detects after safety on delay, alarm and shutdown occur when low oil pressure input is active and lasts for 2s.
- 6) Fail to start: alarm occurs when start still fails after pre-set start attempts.

SmartGen

6 CONNECTION



Fig.2 Back Panel

Table 5 Terminal Connection Description

No.	Function	Cable Size	Note
1	B-	2.0mm ²	Connected with negative of starter battery.
2	B+	2.0mm ²	Connected with positive of starter battery. Max. 20A fuse is recommended.
3	Crank Output	1.5mm ²	B+ power is supplied by terminal 2, rated 10A. Connected with start coil of starter.
4	Fuel Output	1.5mm ²	B+ power is supplied by terminal 2, rated 10A.
5	Ignition Control	1.5mm ²	B- power is supplied by terminal 1, rated 10A.
6	Remote Start Input	1.0mm ²	Aux. input 1, discrete signal input, Ground-connected is active (B-).
7	Oil Pressure Input	1.0mm ²	Aux. input 2, discrete signal input, Ground connected is active (B-).
8	Engine Temp. Sensor	1.0mm ²	Connected with resistor-type temperature sensor.
9	Aux. Output 1	1.0mm ²	B- power is supplied by terminal 1, rated 1A.
10	Aux. Output 2	1.0mm ²	B- power is supplied by terminal 1, rated 1A.
11	Speed Signal Input	1.0mm ²	Connected with ignition coil primary, and diode in series is needed. (Over rated 1A, reverse durable voltage is over 1000V.)
12	Motor S22	Apply stepper motor self-contained wires	Connect with blue cable of stepper motor.
13	Motor S21		Connect with yellow cable of stepper motor.
14	Motor S12		Connect with pink cable of stepper motor.
15	Motor S11		Connect with orange cable of stepper motor.
16	Mains Phase Voltage	1.0 mm ²	Connect with mains output port (2A fuse is recommended)
17	(L-N) Monitoring Input	1.0 mm ²	

No.	Function	Cable Size	Note
18	Generator Phase Voltage	1.0 mm ²	Connect with generator voltage output port (2A fuse is recommended)
19	(L-N) Monitoring Input	1.0 mm ²	

 **Note:** the COM (red cable) for stepper motor shall be connected to battery positive.

7 DEFINITION AND RANGE OF PARAMETERS

7.1 PARAMETER SETTING CONTENTS AND RANGE

Table 6 Controller Configuration Parameters

No.	Items	Parameter Range	Default	Description
P00	Mains Normal Delay	(0-3600)s	10	Time duration for Mains voltage from abnormal to normal or from normal to abnormal is used for ATS to switch.
P01	Mains Abnormal Delay	(0-3600)s	5	
P02	Mians Under Volt Value	(30-360)V	184	If the voltage sample is lower than it, under voltage of Mains is considered; When it is set 30V, under voltage signal shall not be detected.
P03	Mains Over Volt Value	(30-360)V	276	If the voltage sample is higher than it, over voltage of Mains is considered; When it is set 360V, overvoltage signal shall not be detected.
P04	Transfer Delay	(0-99.9)s	1.0	It is the time interval for transferring switch from mains open to generator close or from generator open to mains close.
P05	Mains Options	(0-1)	0	0: AMF(mains abnormal start enabled in auto mode) 1: Display Only (only monitoring mains voltage)
P06	Start Delay	(0-3600)s	1	Time duration from remote start signal is active to engine startup.
P07	Stop Delay	(0-3600)s	1	Time duration from remote start signal is deactivated to engine stop.
P08	Start Attempts	(1-10)	3	It is maximum start attempts when starter fails to start. When it reaches set attempts controller shall send out start failure signal.
P09	Cranking Time	(3-60)s	8	Time for starter to be energized every time.
P10	Crank Rest Time	(3-60)s	10	The waiting time before second power up when engine start fails.
P11	Safety On Delay	(1-60)	10	Alarms for low oil pressure, under frequency and under voltage are deactivated.
P12	Warming Up Time	(0-3600)s	10	Warming-up time before breaker close after high speed running for genset.
P13	Cooling Time	(3-3600)s	10	Radiating time before genset stop after genset is unloaded.



No.	Items	Parameter Range	Default	Description
P14	ETS Solenoid Hold	(0-120)s	20	The time for Stop electromagnet to be energized before genset stop.
P15	Breaker Close Time	(0-10.0)s	0	Pulse width for mains close and generator close. 0s stands for constant output.
P16	Engine Cylinders	(1-2)	1	It is used for judging starter disconnection conditions and detecting engine speed.
P17	Generator Poles	(2-64)	2	Number of engine poles. This value is used for calculating engine speed when controller is without speed sensor .
P18	Generator Abnormal Delay	(0-20.0)s	10.0	Alarm delay for generator under/over voltage.
P19	Generator Over Volt limit for Shutdown	(30-360)V	264	When generator voltage is higher than this threshold and lasts for the set generator abnormal delay, then it shall consider over voltage and shutdown alarm will be initiated. (No detection for over volt signals if it is set as 360V)
P20	Generator Under Volt limit for Shutdown	(30-360)V	196	When sample voltage falls below this threshold and lasts for the delay time, it is considered under voltage and shutdown alarm shall be initiated. (No detection for under volt signals if it is set as 30V)
P21	Under Frequency Shutdown	(0-75.0)Hz	45.0	When generator frequency falls below this threshold and lasts for the delay time, then it is considered under frequency and shutdown alarm signal will be initiated.
P22	Over Frequency Shutdown	(0-75.0)Hz	57.0	When generator frequency is over than this threshold and lasts for the delay time, then it is considered over frequency and shutdown alarm signal will be initiated.
P23	Under Frequency Shutdown Delay	(0-60)s	10	Delay value of generator under frequency.
P24	Over Frequency Shutdown Delay	(0-60)s	2	Delay value of generator over frequency.
P25	Air Flap Blocking Delay	(0-60)s	5	It is available for not applying engine cylinder temp. Sensor. After successful start, the air flap shall keep at the present position for such time and then shall open completely.
P26	Air Flap Blocking Cylinder Temp.	(0-200)°C	30	In the starting process if cylinder temperature is lower than this value, air flap shall close.
P27	Air Flap Open Cylinder Temp.	(0-200)°C	60	After genset starts successfully, if cylinder temperature is higher than this value, air flap



No.	Items	Parameter Range	Default	Description
				shall open. If it is between the blocking value and opening value, the air flap opens 1/2.
P28	Aux. Output 1	(0-9)	5	Default function: generator close output. For details please see Table 8.
P29	Aux. Output 2	(0-9)	6	Default function: mains close output. For details please see Table 8.
P30	Power On Mode Selection	(1-2)	1	1: Manual Mode 2: Auto Mode
P31	Module Address	(1-254)	1	Communication address with PC software.
P32	Password	(0-9999)	0318	Controller password.
P33	Crank Disconnection Conditions	(0-2)	2	0: Generator frequency 1: Engine Speed 2: Generator frequency + engine speed It is used for judging crank disconnection condition.
P34	Disconnection Engine Speed	(0-3000)r/min	840	When engine speed is over this value, it is considered that start is successful and starter will be disconnected.
P35	Disconnection Gen. Frequency	(0-30.0)Hz	14.0	In the starting process when generator frequency exceeds this value, it is considered that start is successful and starter will be disconnected.
P36	Temp Sensor Types	(0-4)	0	0: Not used 1: PT100 2: NTC-1K 3: Reserved 4: Users-defined resistor curves

Table 7 Configurable Parameters Only For HMI

No.	Items	Range	Default	Description
1	Pre-heat Delay	(0-300)s	0	Time for heater plug to be energized in advance before starter is powered on.
2	Start Idle Time	(0-3600)s	0	Idling speed running time when genset is starting.
3	Stop Idle Time	(0-3600)s	0	Idling speed running time when genset is stopping.
4	Stepper Motor Frequency	(100-500)Hz	250	rotation steps for the motor per second
5	Stepper Motor Steps	(0-2000)	128	Step numbers needed for motor rotating 90°; calculation formula: $360 * \text{reduction ratio} / (\text{step angle} * 4)$ for example: $128 = 360 * 16 / (5.625 * 2 * 4)$
6	Ignition Output	(0-1)	0	0: Output when stop 1: Output when start



No.	Items	Range	Default	Description
7	Fuel Output	(0-1)	0	0: Fuel Output 1: ETS Output
8	Digital Input 1	(0-6)	1	Configure the function of controller terminal 6; Default: remote start input, for details please see Table 9.
9	Digital Input 2	(0-6)	2	Configure the function of controller terminal 7; Default: low oil pressure input, for details please see Table 9.

Note: when parameter settings are conducted via PC software, it is needless to enter the password if default password (0318) has not been changed; if it has been changed and it is the first time to conduct parameter settings via PC software, it is needed to enter the module password on the password screen.

7.2 PROGRAMMABLE OUTPUT DEFINABLE CONTENTS

Table 8 Definable Contents For Programmable Outputs

No.	Items	Function Description
0	Not Used	When this is chosen, output port won't output.
1	Common Alarm	When stop alarm is initiated, this alarm will self-lock until alarm reset.
2	ETS Control	It is used for some gensets with stop electromagnet. Pull-in occurs when "stop idle speed" ends. Open occurs when "ETS Delay" ends.
3	Idle Speed Control	It is used for engines with idling speed. Pull-in occurs when the engine starts. Open occurs when it enters "Warming-up". Pull-in occurs in the stopping process of idling speed and open occurs when the genset stops completely.
4	Preheating Control	Close before start, open before energization.
5	Gen Close Output	Generator close outputs when generator is normally running.
6	Mains Close Output	Mains close outputs after mains normal delay ends.
7	Air Flap Choke	It outputs when engine starts, and it disconnects when engine has started.
8	Reserved	
9	Reserved	

7.3 PROGRAMMABLE INPUT DEFINED CONTENTS

No.	Items	Remark
0	Not Used	
1	Remote Start Input	In auto mode, genset starts up if this signal is active.
2	Low Oil Pressure Input	After safety on delay is finished, generator shutdown alarm occurs immediately if this signal is active.
3	Gen Close Input	In manual mode, and under the condition that genset is normally running, generator close outputs when this signal is active, otherwise, mains close outputs.
4	Reserved	
5	Reserved	
6	Reserved	

8 CONTROLLER FUNCTION SETTINGS

Under standby status, press  for 3s, it will enter password entry screen (Fig. 3). At this moment the first digital flashes.



Fig. 3 Password Entry Screen











- a) Press  and the flashing number adds 1; Press  and it decreases 1. After correct setting, press  to move.
- b) For the 2/3/4 digitals it is the same as a) above.
- c) After the password is passed it will enter parameter setting screen. At this moment it displays the serial number of the setting item. Press  and the setting item goes down; Press  and the setting item goes up.



Fig. 4 Parameter Serial Number Screen

- d) Press  and it enters the setting status of the current parameter value. Press  or  and the parameter value can be adjusted. After adjustment press  and the data shall be saved. Press  and the parameter setting screen shall exit.

Notes:

- a) Please change the parameters (such as crank disconnection condition selections, digital inputs, output configurations and all delays) in standby status, otherwise alarm shutdown or other fault information may occur.
- b) For the serial numbers of setting items please refer to the serial numbers in Table 6.
- c) Over voltage threshold must be larger than under voltage threshold, otherwise under/over voltages may occur at the same time.
- d) Generator frequency shall be set as low as possible when the engine has started, so that the start motor can separate as soon as possible.

9 COMMISSIONING

Before official operation, the following checks are suggested to do:

- a) Check all the connections are correct and wire diameter is proper.
- b) Make sure that the controller DC power has fuse, and it is correctly connected to the positive and negative of start battery.
- c) Take proper action to prevent engine from cranking successfully (e. g. Remove the connection wire of gas valve). Make sure everything is correct. Connect starter battery power, and the controller shall conduct the procedure;
- d) Press “Start” button, and genset will start. After the set cranking times, controller will send signal of Start Failure; and then press “Stop” to reset controller.
- e) Recover the action of preventing engine from cranking successfully (e. g. Recover the wire of gas valve). Press Start button again, and genset will start. If everything goes well, genset will normally running. During this period, please observe engine's running state, AC generator's voltage and frequency carefully. If there is something unusual, stop the running genset and check all wire connections according to this manual.
- f) For any other questions please contact with SmartGen service personnel.

SmartGen

10 TYPICAL APPLICATION

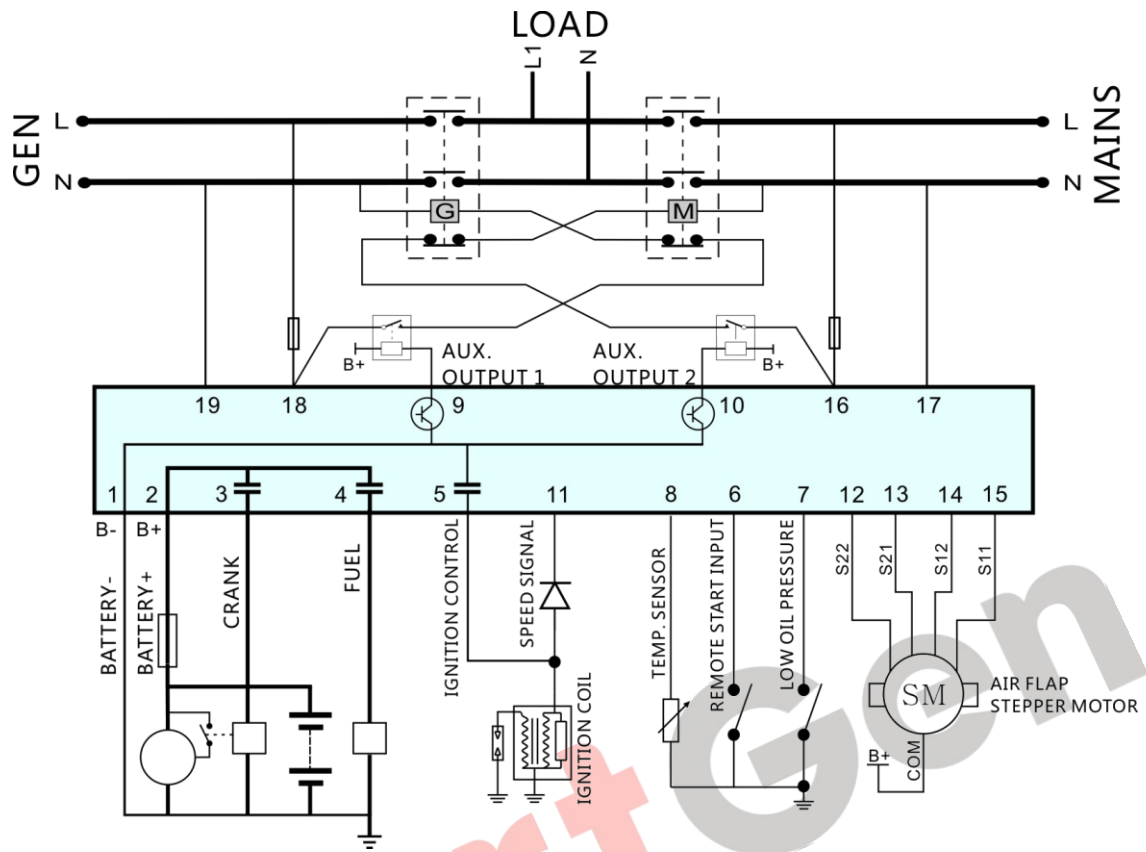

Fig. 5 MGC120 Typical Application Diagram 1

Notes:

- 1) S11、S12、S21、S22 are separately connected with orange wire, pink wire, yellow wire, and blue wire, and stepper motor COM (red wire) shall be connected with the battery positive.
- 2) Terminal 11 must be connected in series with diode. Diode capacity shall be over 1A, and reverse pressure-standing value shall be over 1000V.
- 3) The maximum incoming current for programmable output 1 and output 2 shall be 1A.

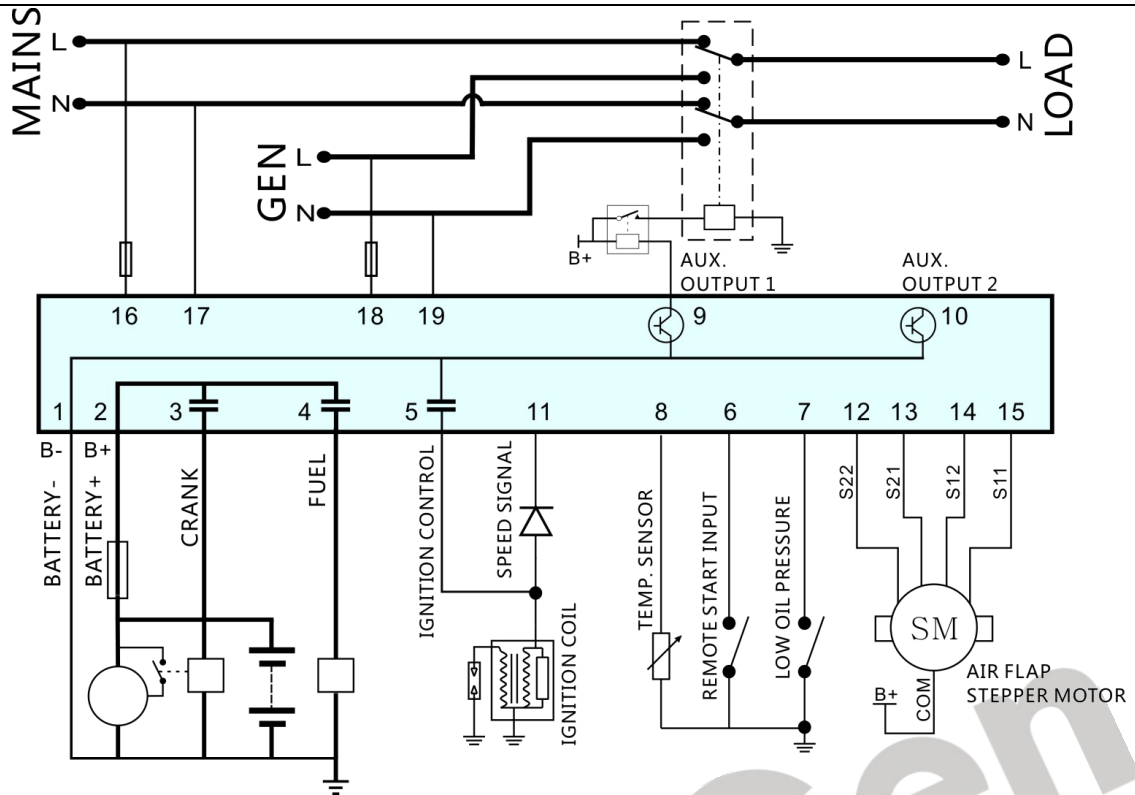

Fig. 6 MGC120 Typical Application Diagram 2

Notes:

- 1) Programmable output 1 shall be set "Generator Close Output".
- 2) S11, S12, S21, S22 shall be connected separately with the stepper motor orange wire, pink wire, yellow wire and blue wire; stepper motor COM (red wire) shall be connected with battery positive.
- 3) Terminal 11 must be in series with diode. Diode capacity shall be over 1A and the reverse pressure-standing value shall be over 1000V.

11 INSTALLATION

11.1 FIXING CLIPS

- The controller is panel-embedded design and the panels are fixed by clips in installation.
- Twist the fixing clip screw anticlockwise until it reaches proper position.
- Pull the fixing clip backwards (towards the back of the module), ensuring two clips are right inside their allotted slots.
- Turn the fixing clip screws firmly clockwise until they are fixed on the panel.

Note:

Pay attention to that the clip screws shall not be turned too tightened.

11.2 OVERALL AND CUTOUT DIMENSIONS

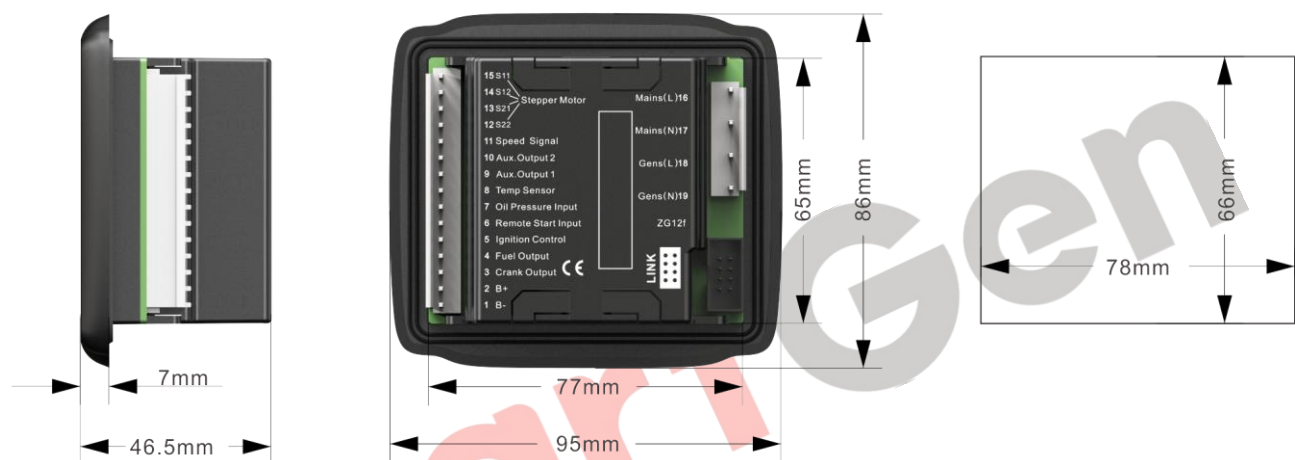

Fig. 7 Overall and Cutout Dimensions

1) **Battery Voltage Input**

MGC120 controller is only suitable for DC12V battery voltage environment. battery Negative must be connected with the engine shell soundly. The diameter of the wire which connects controller power B+/B- and battery positive/negative must be over (or equal to) 1.5mm^2 . If floating charger is configured, please firstly connect charger output wires to battery's positive and negative directly, and then connect battery's positive and negative and controller power's positive and negative individually by another wires in order to prevent charger disturbing the controller's normal working.



Warning: In running process, removing start battery is strictly prohibited.

2) **Withstand Voltage Test**

When the controller has been installed in the control panel, if the high voltage test is conducted, please disconnect controller's all terminals in order to prevent high voltage entering controller and damaging it.

12 FAULT FINDING

Table 10 Fault Finding List

Symptoms	Possible Solutions
Non response when controller is powered on.	Check starting batteries; Check controller connecting wirings; Check DC fuse.
Genset shutdown	Check AC generator voltage.
Low oil pressure alarm after successful start	Check oil pressure sensor and the wirings.
Shutdown Alarm in running process	Check related switches and the wirings according LED indicators;
Start Failure	Check fuel circuit and its connections; Check starting batteries; Check speed sensor and its connections; Refer to engine manual.
Non response for starter	Check starter connections; Check starting batteries.
Air flap stepper motor contrarotation or rotation only in one direction	Check connection wiring order of stepper motor.