



SmartGen
ideas for power

BCB20
BATTERY CHARGING BOX
USER MANUAL



SMARTGEN (ZHENGZHOU) TECHNOLOGY CO., LTD.



Chinese trademark

SmartGen English trademark**SmartGen** — make your generator *smart***SmartGen Technology Co., Ltd.****No.28 Jinsuo Road****Zhengzhou****Henan Province****P. R. China****Tel:** 0086-(0)371-67988888/67981888

0086-(0)371-67991553/67992951

0086-(0)371-67981000(overseas)

Fax: 0086-(0)371-67992952**Web:** www.smartgen.com.cnwww.smartgen.cn**Email:** sales@smartgen.cn

All rights reserved. No part of this publication may be reproduced in any material form (including photocopying or storing in any medium by electronic means or other) without the written permission of the copyright holder.

Applications for the copyright holder's written permission to reproduce any part of this publication should be addressed to Smartgen Technology at the address above.

Any reference to trademarked product names used within this publication is owned by their respective companies.

SmartGen Technology reserves the right to change the contents of this document without prior notice.

Table 1 Software Version

Date	Version	Note
2017-04-20	1.0	Original Release
2020-04-08	1.1	Fixed internal wiring diagram, adjusted the writing format.

CONTENT

1 OVERVIEW	4
2 PERFORMANCE AND CHARACTERISTICS	4
3 CHARGING PRINCIPLE	5
3.1 THREE-STAGE CHARGING DESCRIPTION.....	5
3.2 TWO-STAGE CHARGING DESCRIPTION.....	6
4 SPECIFICATION	7
5 OPERATION.....	8
5.1 KEYS FUNCTION DESCRIPTION.....	8
5.2 CHARGING BOX PANEL	9
5.3 OUTPUT CURRENT SETTING OPERATION	9
5.4 BATTERY TYPE SELECTION OPERATION	9
5.5 CURVES CHECKING OPERATION	10
6 WARNINGS.....	10
7 PARAMETER SETTINGS	11
8 WIRING CONNECTION DIAGRAM.....	14
9 OVERALL DIMENSION AND PANEL CUTOUT	14
10 PACKING LIST	15

SmartGen

1 OVERVIEW

BCB20 battery charging box is intelligent and multi-function which is specially designed for meeting the charging characteristics of the lead-acid engine starter batteries. Suitable for 24V or 12V battery and the maximum charge current is 20A.

With partial graphic LCD, BCB20 can not only display parameters like input/output voltage, current and power, but also can record charging process and form related charging curve to realize real time protection for the battery charge. Parameters can be configured from front panel and language can be chosen between English and Chinese. It has compact structure, simple connections and high reliability.

2 PERFORMANCE AND CHARACTERISTICS

BCB20 battery charging box is composed by BCM4 display module and BACM2420 battery charger.

- a) 132x64 LCD display with backlight, language can be optional(English, Chinese), easy operation.
- b) Collect and display parameters like input/output voltage, current, power and etc.
- c) Record and display battery charging time.
- d) Screen backlight duration can be set.
- e) Monitoring battery charging process, so as to track battery charging stage and display battery voltage which has been charged.
- f) Recording charging volt/current and forming charging curves according to the record.
- g) With fail to communication, fail to charge and mains failure warning display function.
- h) Switching power supply structure with wide AC voltage range and high efficiency.
- i) Users can select automatic two-stage charging process or automatic three-stage charging process as needed. Both the two charging process are carried out according to storage battery charging characteristics to prevent overcharging and significantly prolong battery lifetime.
- j) Built-in PFC circuit can calibrate the power factor above 0.99.
- k) 20A rated charging current, and output current can be adjusted.
- l) It is suitable for 24V battery or suitable for 12V battery after changing the configuration information. It also can be set as self-adaption that can auto adjust battery volt types.

3 CHARGING PRINCIPLE

3.1 THREE-STAGE CHARGING DESCRIPTION

Three-stage method is as follows,

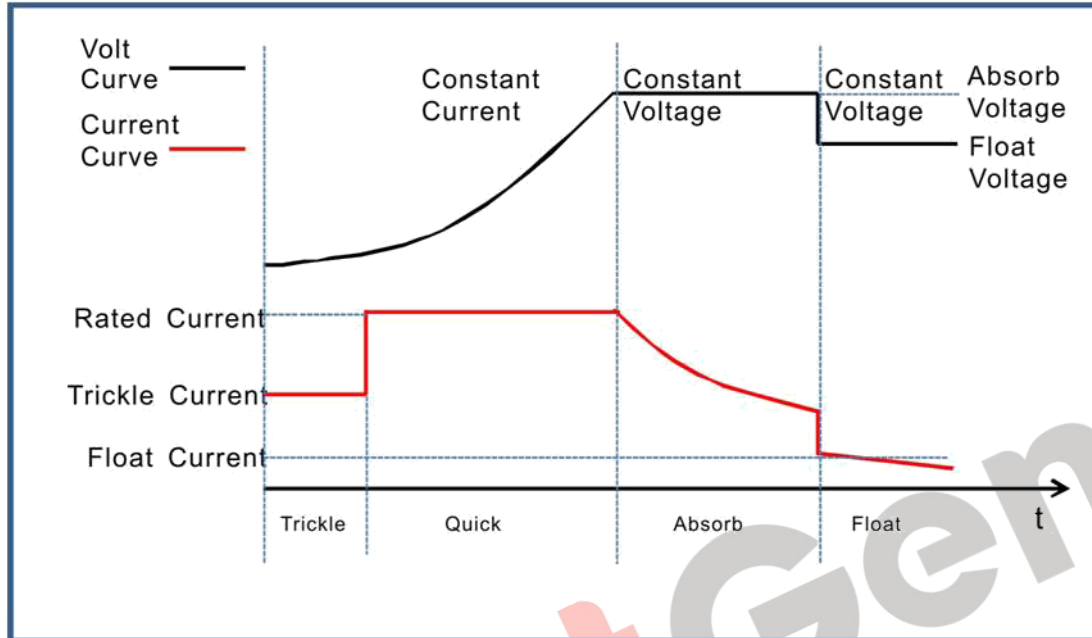

Fig. 1 3-stage Charging Curve

Charging is performed according to the battery charging characteristics using three-stage method.

- 1) The first stage is named as 'constant current': a): Trickle Charge: when the battery terminal voltage is relatively low, then the charging current is low likewise which can prevent the battery temperature is too high. The screen displays "Trickle charging" and charging state indicator flashes. b): Quick Charge: When the battery terminal voltage is relatively high, the charging current will rise to rated value. Large current charging operation leads to an increase in the electricity quantity of the battery. The screen displays "Quick charging" and charging status indicator flashes.
- 2) The second stage is named as Absorption Charge: after the first stage, the battery voltage is rise to absorption charge value rapidly, and the charger voltage will keep constant. The battery terminal voltage will stabilize in the absorption charge value with the decreasing of charging current. The screen displays "Absorption charging" and charging status indicator flashes.
- 3) The third stage is named as Float Charge: After the above two stage, the charge is basically completed and the Float Charge is started automatically. In this stage, the charger voltage reduces to float voltage and the charger current reduces to float value. The screen displays "Float charging" and charging status indicator lights on. When float charging current is below 0.5A, screen displays: Charge complete: float charging". After that charging current will only neutralize the battery self-discharge. Even long-term charging cannot harm the battery, as charger can keep the battery fully charged and so guarantee long lifetime of the battery.

3.2 TWO-STAGE CHARGING DESCRIPTION

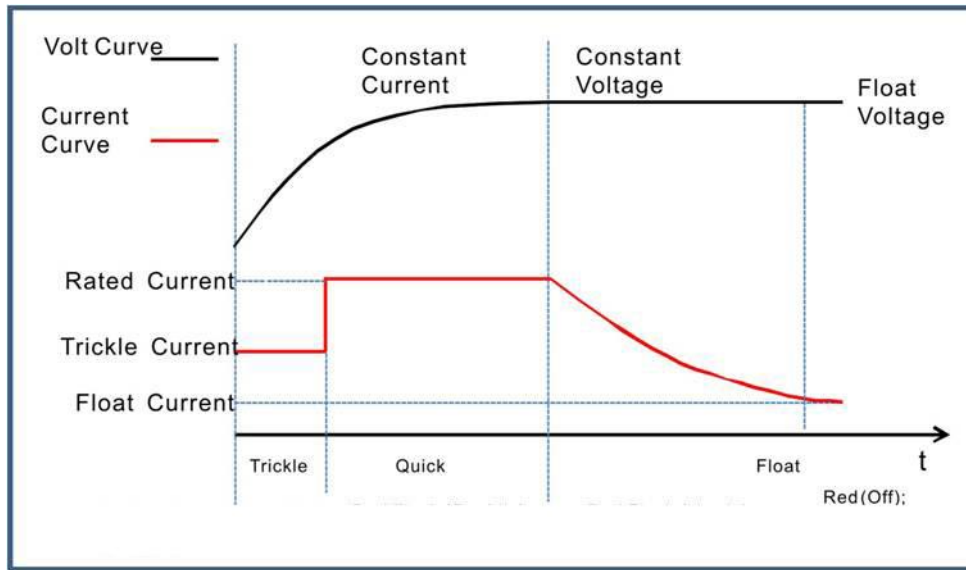

Fig. 2 2-stage Charging Curve

Charging is performed according to the battery charging characteristics using two-stage method.

- 1) The first stage is named as 'constant current':
 - a): Trickle Charge: when the battery terminal voltage is relatively low, then the charging current is low likewise which can prevent the battery temperature is too high. The screen displays "Trickle charging" and charging status indicator flashes.
 - b): Quick Charge: When the battery terminal voltage is relatively high, the charging current will rise to rated value. Large current charging operation leads to an increase in the electricity quantity of the battery. The screen displays "Quick charging" and charging status indicator flashes.
- 2) The second stage is named as Float Charge: The charging current will decrease with the rising of battery electricity. The screen displays "Float charging" and charging status indicator flashes. As soon as charging current value falls below 0.5A, the battery is basically charged. The screen displays "Charge complete: float charging" and charging status indicator lights on. After that charging current will only neutralize the battery self-discharge. Even long-term charging cannot harm the battery, as charger can keep the battery fully charged and so guarantee long lifetime of the battery.

4 SPECIFICATION

Table 2 Technical Parameters

Category	Item	Parameter			
		24V		12V	
Input Performance	Nominal Input AC Volt Range	AC (100~277)V			
	Max Input AC Volt Range	AC (90~305)V			
	AC Frequency	50Hz/60Hz			
	Max Input kW	680W		340W	
	Max Input Current	7A		3.5A	
	Efficiency	AC 110V	AC 220V	AC 110V	AC 220V
		>85%	>87%	>80%	>81%
Power Factor Calibration	AC 110V	AC 220V	AC 110V	AC 220V	
	>0.99	>0.95	>0.99	>0.95	
Output Performance	No-load Output Volt	27V, error±1%		13.5V, error±1%	
	Rated Charging Current	20A, error±2%			
	Max Output Power	580W		290W	
Insulating Property	Insulation Resistance	Between input and output, input and shell all areDC500V10s,: insulation resistance $R_L \geq 1M\Omega$			
	Insulation Voltage	Between input and output, input and shell all are: DC3000V 50Hz 1min leakage current: $I_L \leq 3.5mA$ Between output and shell is: DC800V 50Hz 1min leakage current: $I_L \leq 3.5mA$			
Working Environment	Working Temperature	(-25~+55)°C			
	Storage Temperature	(-25~+70)°C			
	Working humidity	20%RH~93%RH(No condensation)			
Overall Structure	Weight	6.2kg			
	Dimension	315mm×213mm×222mm(L×W×H)			
Air Switch of Output End	Trip Current	32A			
Fuse of Input End	Fusing Current	10A			

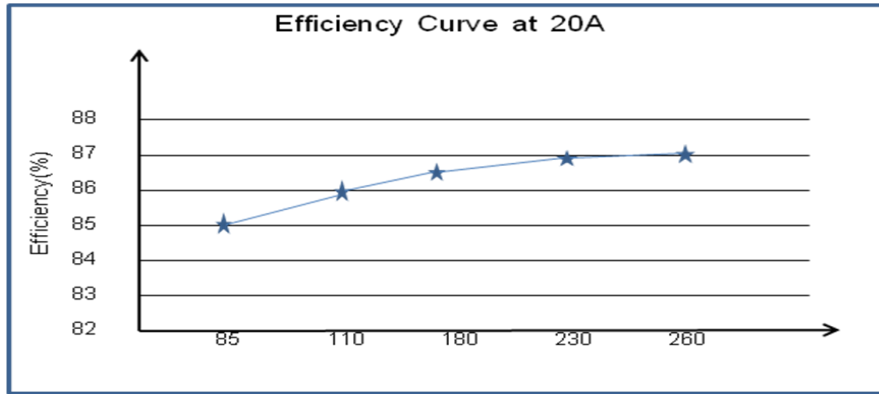









Fig. 3 Efficiency Curve

5 OPERATION

5.1 KEYS FUNCTION DESCRIPTION

Table 3 Key Description

Icon	Function	Description
	Manual Boost	When in float charging stage, press this key to enter into absorption charging mode, and exit absorption charge mode automatically after arriving at absorption charge finished conditions.
	Current Adjust	Press this key to enter into charging current regulation interface so as to set charging current.
	Battery Type Selection	Press this key to select battery type that to be charged, if select self-adaption, charging box will automatic identify the battery types.
	Curves Check	Press this to enter into voltage curves record interface, and re-press it to enter into current curves record interface.
	Home Page	Return to homepage when in main interface; Exit and return back to home page when in parameters setting interface. Hold and press for 3s to enter into lamp testing function.
	Up/Increase	Screen scroll in main interface; Up cursor and increase value in setting menu; Left shift cursor in curves checking interface.
	Set	Press this key to enter menu interface; Shift cursor to confirm In parameters setting menu; Change time coordinate and zoom the coordinate axis in curves checking interface.
	Down/Decrease	Screen scroll in main interface; Down cursor and decrease value in setting menu; Right shift cursor in curves checking interface.

5.2 CHARGING BOX PANEL



Fig. 4 Charging Box Panel

▲ LED Indicator Illustration:

Alarm Indicator: blink when alarms occur; won't illuminate when there is no alarm.

Charging Status Indicator: won't illuminate when there is no battery charging; blink while in charging; indicator is normally on when full charged.

Boost Status Indicator: press Boost key to enter into Boost status and the indicator besides the key is normally on, if not enter into Boost status, it won't illuminate.

12V Battery Indicator: if battery type is selected as 12V or controller judge battery is 12V after choosing self-adaption function, the indicator is always on.

5.3 OUTPUT CURRENT SETTING OPERATION

Press to enter into charging current regulation interface

(showing at right picture), then press to select the number to be changed and increase/decrease it via pressing or .

Re-press to move to the next place to be changed. When reach to the last one, press again to save the parameters.

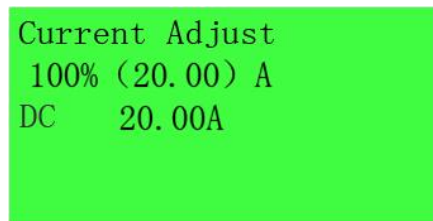

5.4 BATTERY TYPE SELECTION OPERATION



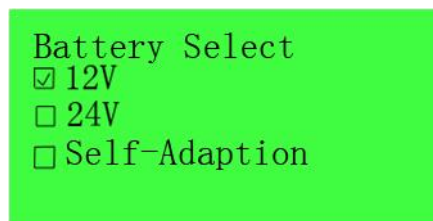

Press to enter into battery selection interface (showing at right picture), then press , the second line 12V battery type is selected and changed it via pressing or .





type is selected, press  to save the option, and the symbol “☑” stands for the battery type following it has been selected.

5.5 CURVES CHECKING OPERATION

press  to enter into voltage curves interface (showing at right picture), and re-press it to enter

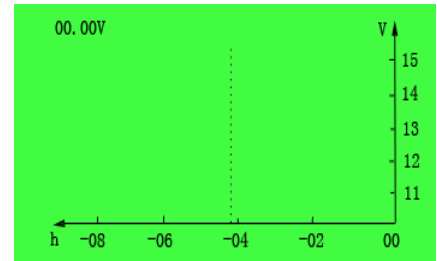
into current curves interface. In curves page, press  or  will left/right shift vertical cursor step by step; hold and press  or  will continuously left/right shift vertical cursor. If cursor position is changed, the corresponding position's record value can be checked. When the cruiser is moved to curved boundary, abscissa of the curve will left/right move one unit time automatically, thus users can check the earlier record.



In curves interface, press  can change the length of unit of time, such as 2h can be changed as 4h, 6h, 8h, and 12h, aiming to compress the curve to show a wider period of time.

6 WARNINGS

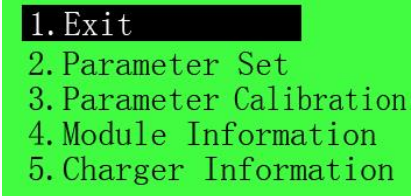









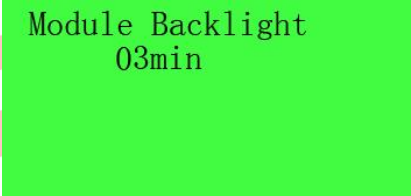









Table 4 Warnings











No.	Type	Description
1	Comm. Fail	If display module cannot receive the data of battery charger, alarm indicator will flash and “Communication Fail” will be displayed in LCD.
2	Mains Fail	When output terminal of charging box does not connect with battery, mains will switch off and charging box will stop working; When connect with battery, controller detects mains switch off, charging box will continue to work if mains recover in 30s, otherwise, alarm indicator will flash and “Mains Fail” will be displayed in LCD.
3	Charging Fail	When charging box in absorption charging status or quick charging status, simultaneously, output current is detected bellow 100mA for more than 30s, then alarm indicator will flash and “Charging Fail” will be displayed in LCD.

7 PARAMETER SETTINGS

 Press  to enter parameter settings menu after start charging box.

Table 5 Parameter Setting Operation Illustration

No.	Interface	Operation
1		Press  or  to upturn or downturn to select the content need to be set, and then press  to enter settings interface. Select 1. Exit and press  to return to the previous page, and then press  to go back to the main interface.
2		After select 2. Parameter settings of No.1 interface, press  or  to upturn or downturn to select the content need to be set, and then press  to enter settings page.
3	 	After select >Module Backlight Set of No.2 interface, press  to enter. Cursor appears on the leftmost number after repressing  . Press  again to right move cursor to select the content that need to be changed, and increase/decrease number value through pressing  /  . After the number selected, press  to right move cursor until the cursor moves over the value group, and then repress  to finish the data setting. At last press  to return to the previous page, and then press  to go back to the main interface.

No.	Interface	Operation
4	<p>Language 0.Simplified Chinese</p> <p>Language 1.English</p>	<p>After select >Language of No.2 interface, press  to enter, and cursor appears after repressing . Select parameter need to be changed, and press  or  to choose the target parameter. Then press  to finish the setting. At last press  to return to the previous page, and then press  to go back to the main interface.</p>
5	<p>Battery Set >Exit >Rated Output Current >Charge Current >Battery Select</p>	<p>After select >Battery Set of No.2 interface, press  to enter. Setting method is same as No.2.No.3 and No.4, and operation details please to see No.2.No.3 and No.4 operation.</p>
6	<p>Module Information Module Type BCM4 SW Ver1.0 2017-03-20 HW Ver1.3 2017-01-21</p>	<p>After select 4. Controller Information of No.1 interface, press  to enter to check controller's model, software/hardware version and the release date.</p>
7	<p>Charger Information Type BACM2420 SW Ver1.0 2017-02-17 HW Ver1.5 2017-01-09</p>	<p>After select 5. Charger Information of No.1 interface, press  to enter to check charger's model, software/hardware version and the release date.</p>

▲ Note: parameter setting values please reference the following *Parameter Content and range Table.*

Table 6 Contents and Range of Parameter Settings

Item	Parameter Range		Factory Default		Description
	24V	12V	24V	12V	
Module Backlight Set	(0-60)min		3min		0min always lights on
Language	(0~1)		0		0: Chinese 1: English
Output Current	Non-adjustable		20.0A		Max charging current
Charging Current	(0~100)%		100%		Max rated charging current percentage.
Battery Selection	(1~3)		2		1: 12V; 2: 24V; 3: Self-adaption
Charging Stage	(2~3)		3		2: Two-Stage; 3: Three-Stage
Absorption Charge Volt	(20~30)V	(10~15)V	28.2V	14.1V	Voltage value in constant volt charging mode.
Float Charge Volt	(20~30)V	(10~15)V	27.0V	13.5V	Voltage value in float charging mode.
Absorption Charge Time Enable	(0~1)		1		0: Disenable; 1: Enable
Absorption Charge Time Set	(0.1~100)h		1.0h		Constant volt charging time
Absorption Charge End Current Enable	(0~1)		1		0: Disenable; 1: Enable
Absorption Charge End Current Set	(0.20~3.00)A		0.5A		Current value when absorption charge turns to float charge.
Auto BOOST Volt Set	(20~30)V	(10~15)V	25.6V	12.8V	When battery charger in float charging status, battery turns to quick charging mode automatically as soon as battery volt drops to this value.
Auto BOOST Volt Delay	(0-3600)s		20s		Battery enters BOOST delay when battery volt drops to BOOST volt.
Low volt Trickle Charge Enable	(0~1)		1		0: Disenable; 1: Enable
Low Volt Trickle Charge Volt	(20~30)V	(10~15)V	22.0V	11.0V	Voltage value of trickle charging.
Low Volt Trickle Charge Current	(0~100)%		50%		Max rated charging current percentage.

8 WIRING CONNECTION DIAGRAM

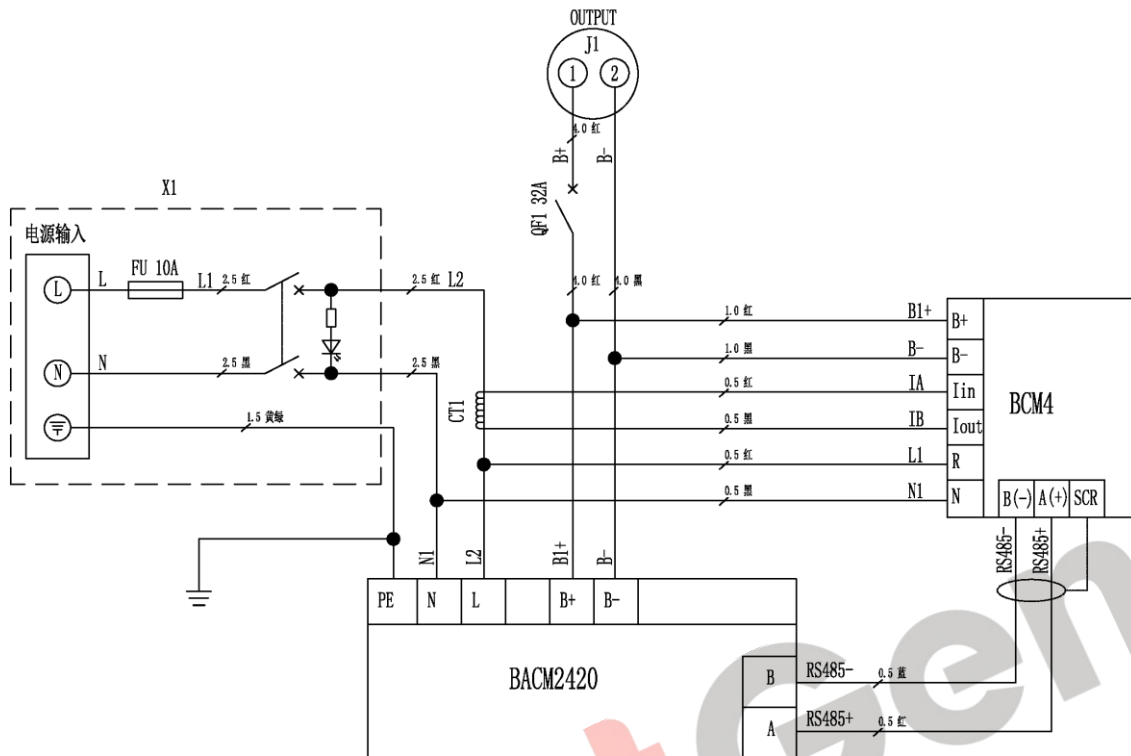

Fig. 5 Wiring Connection Diagram

9 OVERALL DIMENSION AND PANEL CUTOUT

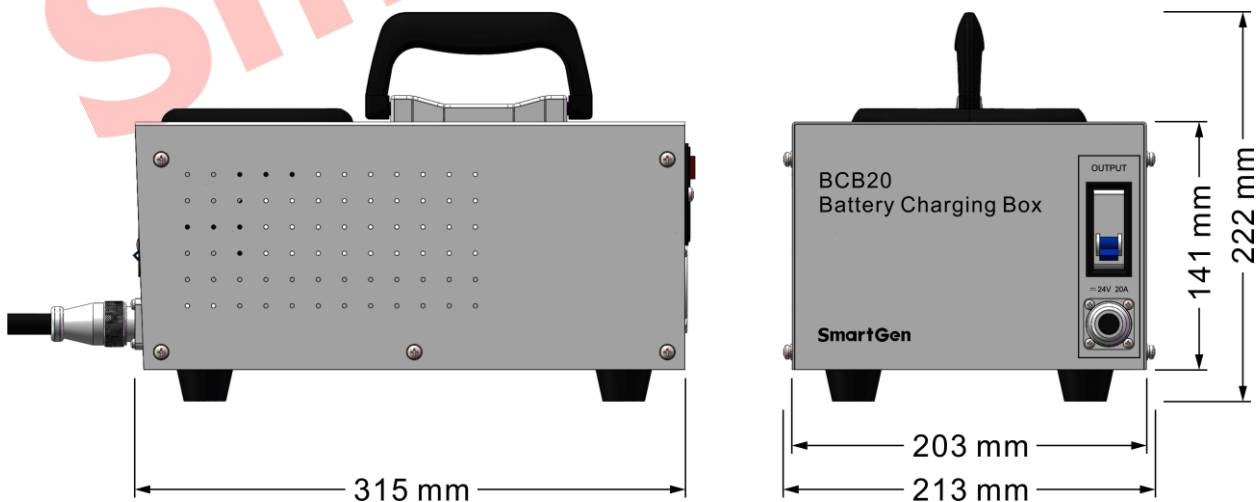

Fig. 6 Overall Dimension and Panel Cutout

10 PACKING LIST

Table 7 Packing List

No.	Name	Quantity	Remark
1	Charging Box	1	
2	AC Input Wire	1	Length: 1.5m Specification: 16A 250V
3	DC Input Wire	1	Length: 1.8m Specification: 20A 250V
4	Certification	1	
5	User Manual	1	

SmartGen