



SmartGen
ideas for power

HGM7220N/HGM7220S SERIES GENSET CONTROLLER USER MANUAL



SMARTGEN (ZHENGZHOU) TECHNOLOGY CO., LTD.



Chinese trademark

SmartGen English trademark

SmartGen — make your generator *smart*

SmartGen Technology Co., Ltd.

No.28 Jinsuo Road

Zhengzhou

Henan Province

P. R. China

Tel: 0086-371-67988888/67981888

0086-371-67991553/67992951

0086-371-67981000(overseas)

Fax: 0086-371-67992952

Web: www.smartgen.com.cn

www.smartgen.cn

Email: sales@smartgen.cn

All rights reserved. No part of this publication may be reproduced in any material form (including photocopying or storing in any medium by electronic means or other) without the written permission of the copyright holder.

Applications for the copyright holder's written permission to reproduce any part of this publication should be addressed to SmartGen Technology at the address above.

Any reference to trademarked product names used within this publication is owned by their respective companies.

SmartGen Technology reserves the right to change the contents of this document without prior notice.

Table 1 - Software Version

| Date | Version | Note |
|------------|---------|-------------------|
| 2019-02-28 | 1.0 | Original release. |
| | | |
| | | |
| | | |



CONTENTS

| | |
|--|-----------|
| 1 OVERVIEW | 5 |
| 2 PERFORMANCE AND CHARACTERISTICS | 6 |
| 3 SPECIFICATION OPERATION | 8 |
| 4 OPERATION | 9 |
| 4.1 KEY FUNCTION | 9 |
| 4.2 CONTROLLER PANEL..... | 10 |
| 4.3 AUTO START/STOP OPERATION..... | 11 |
| 4.3.1. ILLUSTRATION | 11 |
| 4.3.2. AUTO START SEQUENCE | 11 |
| 4.3.3. AUTO STOP SEQUENCE..... | 11 |
| 4.4 MANUAL START/STOP OPERATION..... | 12 |
| 4.5 EMERGENCY START | 12 |
| 5 BREAKER CONTROL PROCESS OF GENSET CONTROLLER | 12 |
| 5.1 HGM7220N BREAKER CONTROL PROCESS | 12 |
| 5.1.1. MANUAL SWITCHING PROCESS | 12 |
| 5.1.2. AUTO SWITCHING PROCESS | 13 |
| 5.2 HGM7220S BREAKER CONTROL PROCESS | 14 |
| 5.2.1. MANUAL SWITCHING PROCESS | 14 |
| 5.2.2. AUTO SWITCHING PROCESS | 14 |
| 6 PROTECTION | 16 |
| 6.1 WARNINGS | 16 |
| 6.2 SHUTDOWN ALARM | 18 |
| 6.3 TRIP AND STOP ALARM | 19 |
| 6.4 TRIP ALARM..... | 20 |
| 7 WIRINGS CONNECTION | 21 |
| 8 SCOPES AND DEFINITIONS OF PROGRAMMABLE PARAMETERS | 24 |
| 8.1 CONTENTS AND SCOPES OF PARAMETERS..... | 24 |
| 8.2 DEFINITION CONTENT OF PROGRAMMABLE OUTPUT PORTS 1~6 | 33 |
| 8.2.1. CUSTOM PERIOD OUTPUT | 37 |
| 8.2.2. CUSTOM COMBINED OUTPUT..... | 38 |
| 8.3 DEFINED CONTENTS OF CONFIGURABLE INPUT PORTS 1~7..... | 38 |
| 8.4 SELECTION OF SENSORS..... | 41 |
| 8.5 CONDITIONS OF CRANK DISCONNECT SELECTION..... | 42 |
| 9 PARAMETERS SETTING | 42 |
| 9.1 MENU ITEMS | 42 |
| 9.2 CONTROLLER PARAMETER SETTINGS..... | 42 |
| 9.3 LANGUAGE SELECTION | 43 |
| 9.4 EVENT LOG | 43 |
| 9.5 CONTROLLER INFORMATION | 43 |
| 9.6 TIME SETTING..... | 43 |
| 9.7 CYCLE START SETTING..... | 43 |
| 9.8 BATTERY UNDER VOLTAGE START SETTING..... | 43 |
| 10 GENSETS CYCLE START | 43 |
| 11 SENSOR SETTING | 44 |



| | |
|--|-----------|
| 12 COMMISSIONING | 45 |
| 13 TYPICAL APPLICATION | 46 |
| 14 INSTALLATION | 47 |
| 14.1 SGE02 EXPANSION MODULE | 47 |
| 14.2 FIXING CLIPS..... | 48 |
| 14.3 OVERALL DIMENSION..... | 49 |
| 15 SMS MESSAGE ALARM AND REMOTE CONTROL | 50 |
| 16.1 SMS MESSAGE ALARM..... | 50 |
| 16.2 SMS MESSAGE REMOTE CONTROL..... | 50 |
| 16 CONNECTIONS OF CONTROLLER AND J1939 ENGINE | 51 |
| 16.1 CUMMINS ISB/ISBE..... | 51 |
| 16.2 CUMMINS QSL9..... | 51 |
| 16.3 CUMMINS QSM11 (IMPORT) | 51 |
| 16.4 CUMMINS QSX15-CM570 | 52 |
| 16.5 CUMMINS GCS-MOVBUS..... | 52 |
| 16.6 CUMMINS QSM11 | 53 |
| 16.7 CUMMINS QSZ13 | 53 |
| 16.8 DETROIT DIESEL DDEC III/IV..... | 53 |
| 16.9 DEUTZ EMR2..... | 54 |
| 16.10 JOHN DEERE..... | 54 |
| 16.11MTU MDEC..... | 55 |
| 16.12MTU ADEC(MODULE MODULE)..... | 55 |
| 16.13MTU ADEC (SAM MODULE) | 55 |
| 16.14PERKINS | 56 |
| 16.15SCANIA | 56 |
| 16.16VOLVO EDC3..... | 56 |
| 16.17VOLVO EDC4 | 56 |
| 16.18VOLVO-EMS2..... | 57 |
| 16.19YUCHAI | 57 |
| 16.20WEICHAI | 58 |
| 17 TROUBLESHOOTING | 59 |
| 18 APPENDIX | 60 |

1 OVERVIEW

HGM7220N/HGM7220S series genset controller is used for single unit automation control, which can realize functions of single unit self-start, AMF, synchronization changeover, and cloud monitoring. It integrates digitalization, intelligence, with network technology. It applies LCD graph display, optional language interface (Chinese, English and etc.) with reliable and simple operating features.

HGM7220N/HGM7220S series genset controller adopts 32-bit micro-processor technology, making it possible to precisely measure most parameters, fixed value adjustment, time setting and limit value adjusting etc. Almost parameters can be configured from front panel of controller, and all parameters can be adjusted through PC software via USB/RS485 port and monitored through PC software via RS485. It can be widely used in all types of genset control automation system with compact structure, simple connections and high reliability.

HGM7220N/HGM7220S series genset controller has network communication module putted inside, so that the genset can be connected with Internet. After the controller logins the cloud server, genset data information (including GPS positioning, altitude etc.) shall be uploaded to the corresponding cloud server at real time, so that users can monitor and check genset running status and event logs by terminal device such as mobile APP (IOS or Android system), PC etc. and at the same time controller parameters can be configured on cloud server. Network communication module has SMS message function.

SmartGen

2 PERFORMANCE AND CHARACTERISTICS

HGM7220N: has mains&generating power monitoring function, which are used for mains/generating automatic changeover control. It is applicable for single unit automation system consisting of one mains circuit and one generating circuit. Mains disable can be performed by parameter setting and at this time it is used for single unit automation and genset self-start and self-stop can be controlled by remote start signal.

HGM7220S: is added mains synchronization changeover function on the basis of HGM7220N.

Main features are the followings:

- 132x64 LCD display with backlit, and selectable language interface (Chinese, English, and other languages) that can be chosen on site, which is convenient for debugging personnel commissioning.
- RS485 communication interface, by which “4 remotes” (remote control, remote measuring, remote communication and remote adjusting) function can be realized through MODBUS protocol.
- Suitable for 3-phase 4-wire, 3-phase 3-wire, single phase 2-wire, and 2-phase 3-wire power systems with voltage 120/240V and frequency 50/60Hz, and HGM7220N can also be used in 400Hz system (please order alone.).
- Collecting and showing 3-phase voltage, 3-phase current, power parameter and frequency of generating or mains power.

Mains

Line voltage (Uab, Ubc, and Uca)
 Phase voltage (Ua, Ub, and Uc)
 Frequency Hz
 Phase sequence

Load

Current Ia, Ib, Ic
 Each phase and total active power P
 Reactive power Q
 Apparent power S
 Power factor PF
 Accumulate total generating power W
 Output percentage with load (active power/rated power)X100%

Generator

Line voltage (Uab, Ubc, and Uca)
 Phase voltage (Ua, Ub, and Uc)
 Frequency Hz
 Phase sequence

A (unit)
 kW (unit)
 kvar (unit)
 kVA (unit)
 kWh, kvarh, kVAh (unit)

— For mains controller has over and under voltage, over and under frequency, loss of phase, and inverse phase sequence functions; and for generator controller has over and under voltage, over and under frequency, over current and over power, reverse power, loss of phase, inverse phase sequence functions.

— Precisely collecting engine parameters:

Temp. (WT) Unit: °C/°F
 Oil Pressure (OP) Unit: kPa/psi/bar
 Fuel Level (FL) Unit: %
 Speed (RPM) Unit: r/min (RPM)
 Battery Voltage Unit: V
 Charger D+ Voltage Unit: V

Total running accumulation maximum 65535 hours.

Start times accumulation maximum 65535 times

— Protection control function: diesel genset automatic start/stop, ATS (Auto Transfer Switch) control

with perfect fault indication and protection functions.

- ETS (energize to stop), idling speed control, pre-heating control and speed rise/drop control functions and all of them are relay outputs.
- Parameter setting function: parameters can be modified and set by users and they won't get lost in case of power outage. Most parameters can be modified on the front panel. All parameters can be adjusted on PC via USB or RS485, or modified on cloud server.
- Multiple temperature, pressure, fuel level sensor curves can be used directly and sensor curves can also be user-defined. Pressure and auxiliary 1 can connect with resistance, voltage or current sensors.
- Multiple crank disconnection conditions (speed, oil pressure, generator frequency) are optional.
- Wide power supply range DC(8~35)V, which is suitable for different starting battery voltage environment.
- Event log, real-time clock, scheduled start & stop (genset start once a day/week/month and load or not can be set.) functions and two gensets circular start function.
- Data recording function for mains voltage, mains frequency, generator voltage, generator frequency, current, temperature, oil pressure, fuel level, speed and etc. one minute before shutdown fault and maximum records are 5.
- Applicable for pumping units as indicating instrument. (only for indication and alarm, none actions for relays.)
- Maintenance function: maintenance time or maintenance time due action can be set (only warning/trip shutdown/alarm shutdown).
- Circular start of two gensets via CAN interface: master running time and backup running time can be set.
- Connecting with cloud server via 4G wireless network is available.
- SMS function: When an alarm occurs, the controller can automatically issue alarm information to 5 mobiles set previously and genset control and genset status check both can be realized by messages.
- GPS positioning function: catching genset position information to realize genset positioning.
- Applying network data communication protocol with JSON format: uploading data if there is data change, and meanwhile compression algorithm is employed to extremely reduce network flow. When an alarm occurs, it can upload data to the server immediately.
- Waterproof security level IP65 due to rubber gasket installed between the controller enclosure and display screen.
- Metal fixing clips are used.
- Modular design, pluggable connection terminals and embedded installation way, and compact structure with easy mounting.

3 SPECIFICATION OPERATION









Table 2 - Technical Parameters

| Items | Contents |
|--|--|
| Working Voltage | DC8.0V to DC35.0V Continuous |
| Whole Power Consumption | <4W (standby ≤2W) |
| Alternator Volt Input: 3Phase 4Wire 3Phase 3Wire Single Phase 2Wire 2Phase 3Wire | 15V AC - 360 V AC (ph-N) 30V AC - 620 V AC (ph-ph) 15V AC - 360 V AC (ph-N) 15V AC - 360 V AC (ph-N) |
| Alternator Frequency | 50 Hz/60Hz 400Hz (Please order separately.) |
| Speed sensor voltage | 1.0V to 24.0V (RMS) |
| Speed sensor Frequency | 10,000 Hz (max.) |
| Starter Relay Output | 16 A 24V DC supply output |
| Fuel Relay Output | 16 A 24VDC supply output |
| Programmable Relay Output 1 | 8A 24V DC power supply output |
| Programmable Relay Output 2 | 8A 250V AC volt free output |
| Programmable Relay Output 3 | 16A 250V AC volt free output |
| Programmable Relay Output 4 | 16A 250V AC volt free output |
| Programmable Relay Output 5 | 8A 24V DC power supply output |
| Programmable Relay Output 6 | 8A 24V DC power supply output |
| Case Dimension | 209mm x 166mm x 45mm |
| Panel Cutout | 186mm x 141mm |
| CT Secondary Current | 5A rated |
| Working Conditions | Temperature: (-25~+70)°C; Humidity: (20~93)% |
| Storage Condition | Temperature: (-30~+80)°C |
| Protection Level | Front panel IP65 |
| Insulating Intensity | Apply AC2.2kV voltage between high voltage terminal and low voltage terminal and the leakage current is not more than 3mA within 1min. |
| Weight | 0.91kg |

4 OPERATION

4.1 KEY FUNCTION

Table 3 - Key Function Descriptions

| Icon | Function | Description |
|---|---------------|--|
|  | Stop/ Reset | Stop the running genset both in Auto/Manual mode; Remove the alarm in stop mode; Press for 3 seconds or over and panel indicators can be tested (lamp test); Press again in stop process and genset shall stop immediately. |
|  | Start | Start genset in manual mode. |
|  | Manual | Set the module to manual mode. |
|  | Auto | Set the module to auto mode. |
|  | C/O | Control breaker close and open in manual mode. |
|  | Set/Confirm | Enter menu list page; Move cursor in parameter setting and confirm the set information. |
|  | Up/Increase | Scrolls the screen up; Shift cursor up or increase the set value in parameter setting. |
|  | Down/Decrease | Scrolls the screen down; Shift cursor down or decrease the set value in parameter setting. |
|  | Home/Return | Return to home page in main interface; Return to last interface in parameter setting; Press for 3 seconds or over, trip alarm can be reset. |

▲ NOTE: press any key to mute alarms in main screen.

4.2 CONTROLLER PANEL

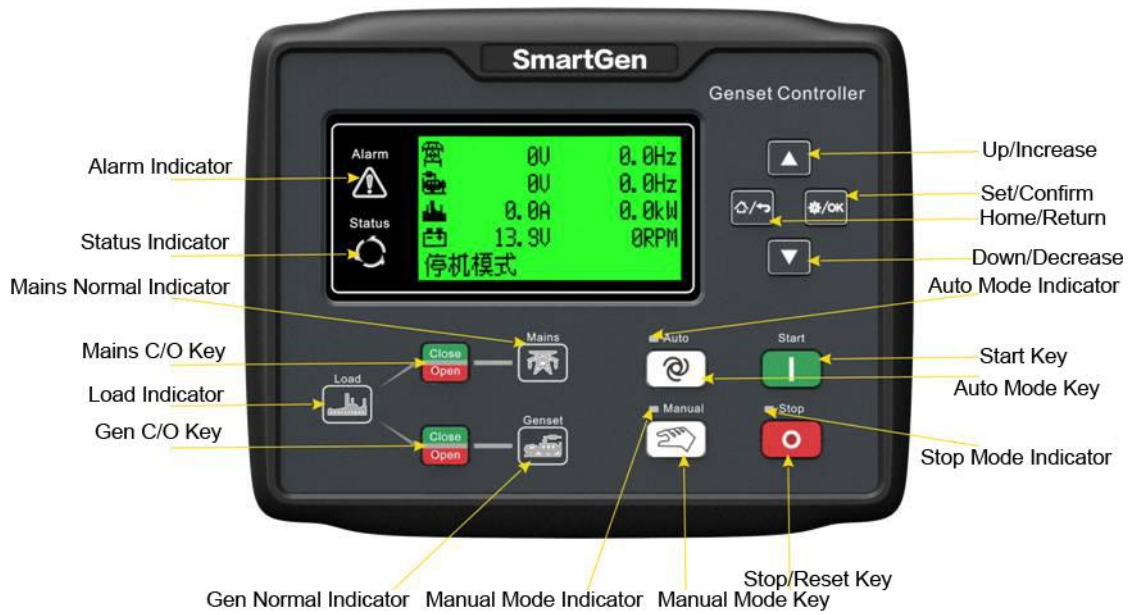

Figure 1 - HGM7220N/7220S Front Panel Indication

NOTE: Illustration for part indicators.

Table 4 - Alarm Indicator Description

| Alarm Type | Alarm Indicators |
|---------------------|------------------------------------|
| Warning alarm | slowly flashing (once per second) |
| Trip alarm | slowly flashing (once per second) |
| Shutdown alarm | fast flashing (5 times per second) |
| Trip and stop alarm | fast flashing (5 times per second) |

NOTES:

- a) Status Indicators: illuminate always after crank disconnection and before ETS; extinguished during other periods.
- b) Gen Normal Indicator: illuminates always when generator is normal; flashes when generator is abnormal; extinguished when generator is standby.
- c) Mains Normal Indicator: illuminates always when mains is normal; flashes when mains is in fault; extinguished when gen is standby.
- d) When mains is disabled, mains normal indicator is extinguished, and meanwhile mains C/O key does not work.

4.3 AUTO START/STOP OPERATION

4.3.1. ILLUSTRATION

Press  and the indicator beside is illuminated, meaning genset is in Auto Start mode.

4.3.2. AUTO START SEQUENCE

a) HGM7220N/HGM7220S Start Conditions:

Mains Enable: When mains is abnormal (over and under voltage, over and under frequency, loss of phase and inverse phase), genset enters “mains abnormal delay” and LCD displays countdown time. When mains abnormal delay is over, it enters “start delay”. Or when remote start (load on) input is active, it enters “start delay”.

Mains Disable: When remote start (load on) input is active, genset enters “start delay”.

- b) “start delay” countdown is shown on LCD.
- c) When start delay is over, preheating relay outputs (if configured), “Pre-heat Delay XX s” is shown on LCD.
- d) When preheating delay is over, fuel relay outputs for 1s. Then start relay outputs; if engine cranking fails during “cranking time”, the fuel relay and start relay are deactivated and enter “crank rest time” waiting for next crank.
- e) If engine crank fails within setting times, controller will initiate “failed to start” shutdown signal and “failed to start” message appears on LCD display at the same time.
- f) In case of successful cranking, “safety on time” starts. During this period, low oil pressure, high water temperature, under speed, and charge failure alarms are disabled. As soon as “safety on delay” is over, “start idle delay” is initiated (if configured).
- g) During “start idle delay” period, under speed, under frequency, under voltage alarms are inhibited. When this delay is over, “warming up delay” starts (if configured).
- h) In case mains is abnormal and HGM7220N remote start (on-load) input is active, when “warming up delay” is over, if generator status is normal, the indicator will be illuminated; if voltage and frequency has reached on-load requirements, the closing relay will be energized, generator will accept load, generator power indicator will be lit on, and generator will enter Normal Running status; if voltage and frequency are abnormal, the controller will initiate shutdown alarm (shutdown alarm will be displayed on LCD alarm page).
- i) In case HGM7220S remote start (on-load) input is active, when “warming up delay” is over, if generator status is normal then the generator status indicator shall be illuminated. Until genset and mains satisfy the synchronization conditions, the controller shall issue close signal and when the controller detects the close feedback signal, it shall issue immediately the open signal, and genset is on-load.





▲NOTE: when remote start (off-load) signal input is active, the auto start sequence is the same as above except item h), generator closing relay will not output, and genset is off-load.

4.3.3. AUTO STOP SEQUENCE



- a) In case HGM7220N/7220S genset is at normal running, if mains recovers normal, genset shall enter mains voltage “normal delay”. As soon as mains normal status is confirmed, mains status indicator shall be illuminated and “stop delay” starts; Or if remote start input is not active, “stop delay” starts.
- b) As soon as “stop delay” is over,

- ① **HGM7220N:** starts “cooling delay”, meanwhile generating close relay is disconnected. After “transfer reset delay”, mains close relay outputs, mains is on-load, gens power supply indicator is light off, m and mains supply indicator is light on.
- ② **HGM7220S:** and mains meet the synchronization conditions, the controller shall issue mains close signal. When the controller detects mains close feedback signal, it shall give out immediately the gens open signal, gens supply indicator is extinguished, mains is on-load, mains supply indicator is illuminated, and genset starts “cooling delay”.
 - c) When genset enters “stop idle delay” (if configured), idle relay is energized and outputs.
 - d) When genset enters “ETS hold delay”, ETS relay is energized. Fuel relay is deactivated and detects whether it stops or not automatically.
 - e) Then it enters “wait stop time”, and controller shall detects whether genset stops or not is automatically.
 - f) After genset is stopped completely, it enters “after stop delay”, otherwise it enters “failed to stop” and the controller issue “failed to stop” warning (after stop failure warning, if gen-set stops after the alarm, it will enter “after stop delay” and “failed to stop” alarm will be eliminated automatically).
 - g) When “after stop delay” is over, genset shall enter standby status.

4.4 MANUAL START/STOP OPERATION

- a) **HGM7220N/7220S:** Press  button and controller enters “Manual Mode”, Manual Mode indicator is illuminated. In this mode, Press  button and genset is started. Start success is detected automatically and genset goes up to high speed running automatically. In case high water temperature, low oil pressure, over speed and abnormal voltage occur during diesel genset running, controller can effectively protect genset to stop (for detailed procedures please refer to 4.3.2 Auto Start Sequence c~i.). In manual mode, load breaker won't transfer automatically. It needs to press   C/O key to open/close.
- b) **Manual Stop:** press  key and the running genset shall be stopped. (for detailed procedures please refer to 4.3.3 Auto Stop Sequence b-g.)

4.5 EMERGENCY START



Simultaneously press  and  in manual mode and the generator shall be forced to crank. Successful start will not be judged according to crank disconnect conditions, but controlled by operator. When operator observes that the genset has started, he/she should release the button and start output will be deactivated. “Safety on delay” will be initiated.





5 BREAKER CONTROL PROCESS OF GENSET CONTROLLER





5.1 HGM7220N BREAKER CONTROL PROCESS





5.1.1. MANUAL SWITCHING PROCESS

Breaker is switched by manual control if controller in manual mode.

Operator controls load transfer of ATS via pressing   button.

Mains Enable: When breaker open detection is disabled, (1) press generator   button, open breaker will output if generator is on-load; generator will be closed if load is disconnected; mains will be opened if mains is on-load, and generator is closed after open delay is over; (2) press mains   button, if mains is on-load, open breaker output; if load is disconnected, mains will be closed; if generator is on-load, generator will be opened, and mains will be closed after open delay is over.

If breaker open detection is enabled, mains on-load is changed to gens on-load. It is needed to press mains   and press generator   after open delay, then generator is closed (directly press gens close button, and none action occurs.). Gens on-load is changed to mains on-load, which is the same as above.

Mains Disable: Press generator   button, and if generator is not on-load, then generator close outputs. Press generator   and if generator is on-load, then generator open outputs.

5.1.2. AUTO SWITCHING PROCESS

Breaker is switched by automatic control if controller is in auto mode or stop mode.

a) In case input port is configured as close status auxiliary input,

Mains Enable:

When breaker open detection is enabled, mains on-load changes to generator on-load. After open delay and transfer rest delay, in the process of open output, transfer failure is detected. When the detection time is due, if open fails, then generator close does not occur, otherwise generator close occurs. In the process of generator close, transfer failure is detected. When the detection time is due, if close fails, then generator close is waited for. If transfer failure warning is enabled, then open/close failures shall issue warning signals. For generator on-load transfers to mains on-load, it is the same process as above.

When breaker open detection is disabled, mains on-load changes to generator on-load. After open delay and transfer rest delay, generator close occurs. In the process of generator close, transfer failure is detected. When the detection time is due, if close fails, then generator close is waited for. If transfer failure warning is enabled, then warning signal is issued. For generator on-load transfers to mains on-load, it is the same process as above.

Mains Disable:

When breaker open detection is enabled, mains on-load changes to generator on-load. After open delay in the process of open output, transfer failure is detected. When the detection time is due, if open fails, then open is waited for, otherwise open is completed. For generator off-load changing to generator on-load, after close delay, in the process of close output, transfer failure is detected. When the detection time is due, if close fails, then close is waited for, otherwise close is completed.

If transfer failure warning is enabled, then open/close failures shall issue warning signals.

When breaker open detection is disabled, generator on-load changes to generator off-load. After open delay, open is completed. For generator off-load changing to generator on-load, after close delay, in the process of close output, transfer failure is detected. When the detection time is due, if close fails, then close is waited for, otherwise close is completed. If transfer failure warning is enabled, then close

failure shall issue warning signal.

b) In case input port is not configured as close status auxiliary input,

Mains Enable:

For mains on-load changing to generator on-load, after open delay and transfer rest delay, generator close occurs. For generator on-load changing to mains on-load, it is the same as above.

Mains Disable:

For generator off-load changing to generator on-load, generator close outputs. For generator on-load changing to generator off-load, generator open outputs.

▲NOTE: In case of applying ATS without neutral breaking, open detection shall be disabled.

▲NOTE: In case of applying ATS with neutral breaking, open detection can be enabled and disabled. If it is enabled, please configure open output.

▲NOTE: In case of applying AC contactor, open detection is recommended to be enabled.

5.2 HGM7220S BREAKER CONTROL PROCESS

5.2.1. MANUAL SWITCHING PROCESS

Breaker is switched by manual control if controller in manual mode.

Operator controls ATS load transfer via C/O button.

Mains Enable:

Press generator   button,

1. In case of generator on-load, then generator open outputs;
2. In case of generator&mains off-load, then generator close occurs;
3. In case of mains on-load, when generator synchronization close is over, mains open occurs and generator is on-load.

▲NOTE: In the process of waiting for synchronization or if synchronization fails, press generator C/O button to cancel synchronization, and generator breaker is open. Then press mains C/O button to force mains on-load.

Mains Disable:

Press generator C/O button, and if generator is off-load, then generator close outputs; if generator is on-load, then generator open outputs.

5.2.2. AUTO SWITCHING PROCESS

Breaker is switched by automatic control if controller in auto mode.

Mains Enable:

1. For mains on-load changing to generator on-load,

Controller shall output generator close when genset and mains meet synchronization conditions. When it detects generator close feedback signal, mains open outputs and generator is on-load. If generator close is outputted, generator close feedback signal is not detected during the C/O synchronization period, generator open is outputted and mains is on-load. Mains open status is detected at the time of mains open output. When the C/O synchronization time is due, if mains open fails, generator open outputs. If synchronization signal is not detected during the set synchronization failure time, then synchronization failure alarm is issued. If synchronization failure alarm is warning and transfer is forced to be enabled after synchronization failure ten mains open outputs. After open delay, mains open status is detected at the time of mains open output. When detection time is due, if mains open fails, then generator shall not close, otherwise, after transfer delay generator close outputs. Generator close status is detected at the time of generator close output. When the detection time is

due, if generator close fails generator close is waited for.

2. If input port not configured as close status auxiliary input

Controller shall output mains close when genset and generator meet synchronization conditions. When it detects mains close feedback signal, generator open outputs and mains is on-load. If mains close is outputted, mains close feedback signal is not detected during the C/O synchronization period, mains open is outputted and generator is on-load. Generator open status is detected at the time of generator open output. When the C/O synchronization time is due, if generator open fails, mains open outputs. If synchronization signal is not detected during the set synchronization failure time, then synchronization failure alarm is issued. If synchronization failure alarm is warning and transfer is forced to be enabled after synchronization failure, then generator open outputs. After open delay, generator open status is detected at the time of generator open output. When detection time is due, if generator open fails, then mains shall not close, otherwise, after transfer delay mains close outputs. Mains close status is detected at the time of mains close output. When the detection time is due, if mains close fails mains close is waited for.

Mains Disable:

For generator off-load changing to generator on-load, generator close outputs. For generator on-load changing to generator off-load, generator open outputs.

▲NOTE: Mains close status and Generator close status are needed to be configured for input port, otherwise controller shall issue mains breaker failure warning or generator breaker failure warning.

▲NOTE: For synchronization failure alarm, it is needed to press  longer to remove the alarm.

▲NOTE: If synchronization C/O detection time is less than breaker C/O time, then synchronization C/O detection time is breaker C/O time.

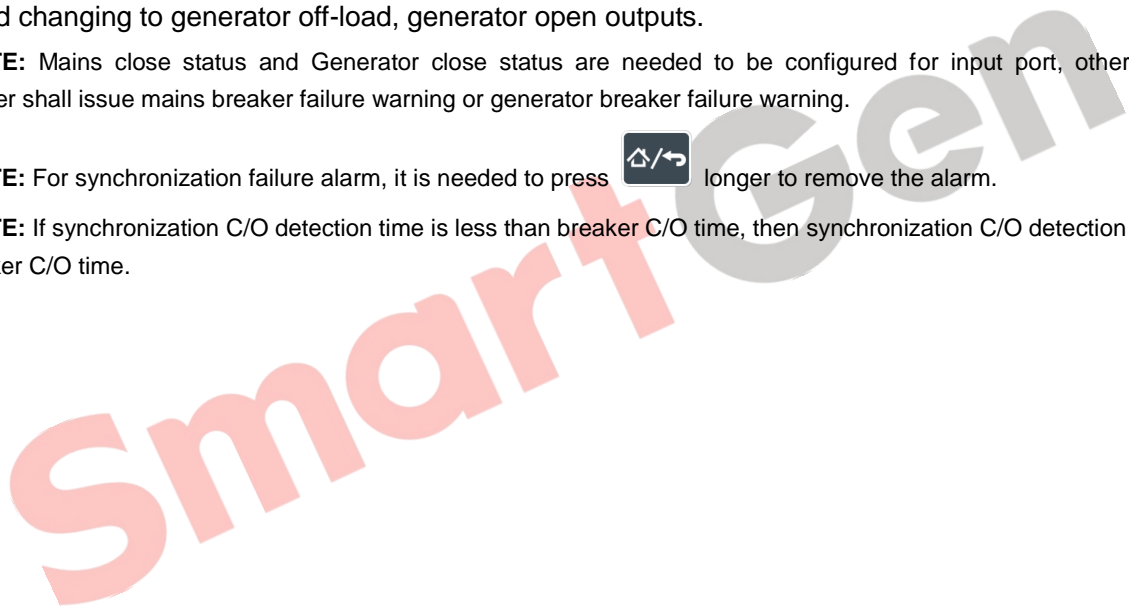

6 PROTECTION

6.1 WARNINGS

When controller detects the warning alarms, it only issues alarm and does not stop the genset.

Table 5 - Warning Alarm Types

| No. | Type | Description |
|-----|----------------------|---|
| 1 | Gen. Over Speed | When the controller detects that the genset speed exceeds the pre-set limit, it will initiate a warning alarm. |
| 2 | Gen. Under Speed | When the controller detects that the genset speed falls below the pre-set limit, it will initiate a warning alarm. |
| 3 | Loss of Speed Signal | When the controller detects that the speed of genset is zero and action is selected "Warning", it will initiate a warning alarm. |
| 4 | Gen. Over Frequency | When the controller detects that the frequency of genset exceeds the pre-set limit, it will initiate a warning alarm. |
| 5 | Gen. Under Frequency | When the controller detects that the frequency of genset falls below the pre-set limit, it will initiate a warning alarm. |
| 6 | Gen. Over Voltage | When the controller detects that the voltage of genset exceeds the pre-set limit, it will initiate a warning alarm. |
| 7 | Gen. Under Voltage | When the controller detects that the voltage of genset falls below the pre-set limit, it will initiate a warning alarm. |
| 8 | Gen. Over Current | When the controller detects that the current of genset exceeds the pre-set limit, it will initiate a warning alarm. |
| 9 | Failed to Stop | If engine does not stop completely when "failed to stop" delay is expired, it will initiate a warning alarm. |
| 10 | Charge Alt Fail | When the controller detects that the voltage of charger falls below the pre-set limit, it will initiate a warning alarm. |
| 11 | Battery High Voltage | When the controller detects that the battery voltage of genset exceeds the pre-set limit, it will initiate a warning alarm. |
| 12 | Battery Low Voltage | When the controller detects that the battery voltage of genset falls below the pre-set limit, it will initiate a warning alarm. |
| 13 | Maintenance Time Due | When maintenance countdown is zero and action is selected "Warning", it will initiate a warning alarm. |
| 14 | Reverse Power | When controller detects that the reverse power value (power is negative) of genset exceeds the pre-set limit, and action is selected "Warning", it will initiate a warning alarm. |
| 15 | Over Power | When controller detects that the power value (power is positive) of genset exceeds the pre-set limit, and action is selected "Warning", it will initiate a warning alarm. |
| 16 | ECU Warn | When controller receives engine warning signal via J1939, it initiate a warning signal. |
| 17 | Gen. Loss of Phase | When controller detects that the phase of generator is lost, it will initiate a warning alarm. |



| No. | Type | Description |
|-----|----------------------------------|---|
| 18 | Gen. Reverse Phase | When controller detects that the phase sequence of generator is wrong, it will initiate a warning alarm. |
| 19 | Fail to Sych Warn | HGM7220S controller: When controller is in auto mode, if synchronization signal is not detected during the synchronization time for mains synchronization close and generator synchronization close, it shall issue a warning signal. |
| 20 | Gen Breaker Fail | HGM7220S controller: generator close status is not configured for input port, the controller shall issue a warning signal. |
| 21 | Gen Breaker Fail | HGM7220S controller: mains close status is not configured for input port, the controller shall issue a warning signal. |
| 22 | Breaker Switch Fail | When controller detects that the breaker fails to close/open (when the warning is enabled), it will initiate a warning alarm. |
| 23 | Temp. Sensor Open Circuit | When controller detects that the temperature sensor is open circuit and action is selected "Warning", it will initiate a warning alarm. |
| 24 | High Temp. Warn | When controller detects that the temperature is higher than the pre-set value, it will initiate a warning alarm. |
| 25 | Low Temp. Warn | When controller detects that the temperature is lower than the pre-set value, it will initiate a warning alarm. |
| 26 | Oil Pressure Sensor Open Circuit | When controller detects that sensor is open circuit, and action type is selected "Warning", it will initiate a warning alarm. |
| 27 | Low Oil Pressure Warn | When controller detects that the oil pressure value falls below the pre-set value, it will initiate a warning alarm. |
| 28 | Level Sensor Open Circuit | When controller detects that sensor is open circuit, and action is selected "Warning", it will initiate a warning alarm. |
| 29 | Low Level Warning | When controller detects that the liquid level value falls below the pre-set value, it will initiate a warning alarm. |
| 30 | Config. Sensor 1 Open Circuit | When controller detects that sensor is open circuit, and action is selected "Warning", it will initiate a warning alarm. |
| 31 | Config. Sensor 1 High | When controller detects that the sensor value exceeds the pre-set upper limit, it will initiate a warning alarm. |
| 32 | Config. Sensor 1 Low | When controller detects that the sensor value falls below the pre-set lower limit, it will initiate a warning alarm. |
| 33 | Config. Sensor 2 Open Circuit | When controller detects that sensor is open circuit, and action is selected "Warning", it will initiate a warning alarm. |
| 34 | Config. Sensor 2 High | When controller detects that the sensor value exceeds the pre-set upper limit, it will initiate a warning alarm. |
| 35 | Config. Sensor 2 Low | When controller detects that the sensor value falls below the pre-set lower limit, it will initiate a warning alarm. |
| 36 | Input Warn | When digital input port is configured as "Warning", and if it is active, controller will initiate a warning alarm. |
| 37 | Cycle Com Fail Warn | When two gensets, which during in cycle start status, fail to communicate, controller will initiate a warning alarm. |
| 38 | GSM Com Fail Warn | When SGE02 (4G wireless com. expansion card) is enabled, and GSM module is not detected, the controller shall issue a warning signal. |

6.2 SHUTDOWN ALARM

When controller detects shutdown alarms, it will send signals to stop the generator and the corresponding alarm information will be displayed on LCD.

Table 6 - Shutdown Alarms

| No. | Type | Description |
|-----|----------------------------------|---|
| 1 | Emergency Stop | When controller detects emergency stop signals, it will send stop signals. |
| 2 | Over Speed | When controller detects the speed value is higher than the set value, it will send stop signals. |
| 3 | Under Speed | When controller detects the speed value is lower than the set value, it will send stop signals. |
| 4 | Loss of Speed Signal | When controller detects speed value equals 0, and action is selected "Shutdown", it will send stop signals. |
| 5 | Over Frequency | When controller detects the frequency value is higher than the set value, it will send stop signals. |
| 6 | Under Frequency | When controller detects the frequency value is lower than the set value, it will send stop signals. |
| 7 | Over Voltage | When controller detects the voltage value of genset is higher than the set value, it will send stop signals. |
| 8 | Under Voltage | When controller detects the voltage value of genset is lower than the set value, it will send stop signals. |
| 9 | Failed to Start | If genset start fails within the preset start attempts, controller will send stop signals. |
| 10 | Over Current | When controller detects the current value is higher than the set value and action is selected "Shutdown", it will send stop signals. |
| 11 | Maintenance Over Time | When maintenance time countdown equals 0, and action is selected "Shutdown", it will send stop signals. |
| 12 | Reverse Power Shutdown | When controller detects that the reverse power value (power is negative) of genset exceeds the pre-set value, and action is selected "Shutdown", it will send stop signals. |
| 13 | Over Power Shutdown | When controller detects that the power value (power is positive) of genset exceeds the pre-set value, and action is selected "Shutdown", it will send stop signals. |
| 14 | Temp. Sensor Open Circuit | When controller detects sensor is open circuit, and action is selected "Shutdown", it will send stop signals. |
| 15 | High Temp. Shutdown | When controller detects temperature of water/cylinder is higher than the set value, it will send stop signals. |
| 16 | Oil Pressure Sensor Open Circuit | When controller detects sensor is open circuit, and the action is selected "Shutdown", it will send stop signals. |



| No. | Type | Description |
|-----|-------------------------------|---|
| 17 | Low Oil Pressure Shutdown | When controller detects oil pressure is lower than the set value, it will send stop signals. |
| 18 | Level Sensor Open Circuit | When controller detects sensor is open circuit, and the action is selected "Shutdown", it will send stop signals. |
| 19 | Low Level Shutdown | When controller detects liquid level is lower than the set value, it will send stop signals. |
| 20 | Config. Sensor 1 Open Circuit | When controller detects that sensor is open circuit, and action is selected "Shutdown", it will send stop signals. |
| 21 | Config. Sensor 1 High | When controller detects that the sensor value exceeds the pre-set upper limit, it will send stop signals. |
| 22 | Config. Sensor 1 Low | When controller detects that the sensor value falls below the pre-set lower limit, it will send stop signals. |
| 23 | Config. Sensor 2 Open Circuit | When controller detects that sensor is open circuit, and action type is select "Shutdown", it will send stop signals. |
| 24 | Config. Sensor 2 High | When controller detects that the sensor value exceeds the pre-set upper limit, it will send stop signals. |
| 25 | Config. Sensor 2 Low | When controller detects that the sensor value falls below the pre-set lower limit, it will send stop signals. |
| 26 | Input Alarm Shutdown | When digital input port is configured as "Shutdown", and if it is active, controller will send stop signals. |
| 27 | Gen Phase Seq Wrong | HGM7220S: when controller detects inverse gens phase sequence or wrong sequence, controller shall issue stop alarm. |

6.3 TRIP AND STOP ALARM

When controller detects trip and stop alarms, it will immediately disconnect the generator close signals and genset shall stop after high-speed cooling.

Table 7 - Trip and Stop Alarms

| No. | Type | Description |
|-----|-----------------------|--|
| 1 | Over Current | When controller detects the genset current is above the set value and action is selected "Trip and Stop", it will send trip and stop signals. |
| 2 | Maintenance Over Time | When maintenance time countdown equals 0, and action is selected "Trip and Stop", it will send trip stop signals. |
| 3 | Reverse Power | When controller detects that the genset reverse power (power is negative) exceeds the pre-set value, and action is selected "Trip and Stop", it will send trip and stop signals. |
| 4 | Over Power | When controller detects that the genset power value (power is positive) exceeds the pre-set value, and action is selected "Trip and Stop", it will send trip and stop signals. |
| 5 | Input Trip and Stop | When input port is configured as "Trip and Stop", and if it is active, controller will send trip and stop signals. |

6.4 TRIP ALARM

When controller detects trip alarms, it will immediately disconnect the generator close signals but genset does not stop.

Table 8 - Trip Alarms

| No. | Type | Description |
|-----|--------------------|---|
| 1 | Over Current | When controller detects the genset current value is higher than the set value and action is selected "Trip", it will send trip signals. |
| 2 | Reverse Power | When controller detects that the genset reverse power value (power is negative) exceeds the pre-set value, and action is selected "Trip", it will send trip signals. |
| 3 | Over Power | When controller detects that the genset power value (power is positive) exceeds the pre-set value, and action is selected "Trip", it will send trip signals. |
| 4 | Input Trip | When input port is configured as "Trip", and if it is active, controller will send trip signals. |
| 5 | Mains Breaker Fail | HGM7220S controller: when controller detects mains C/O fails, it shall issue the alarm signal. |
| 6 | Gen Breaker Fail | HGM7220S controller: when controller detects generator C/O fails, it shall issue the alarm signal. |
| 7 | Fail to Sync | HGM7220S controller: When controller is in auto mode, if synchronization signal is not detected during the synchronization time for mains/generator synchronization close, it shall issue a warning signal. |

7 WIRINGS CONNECTION

HGM7220N/7220S controller back panel is as below.

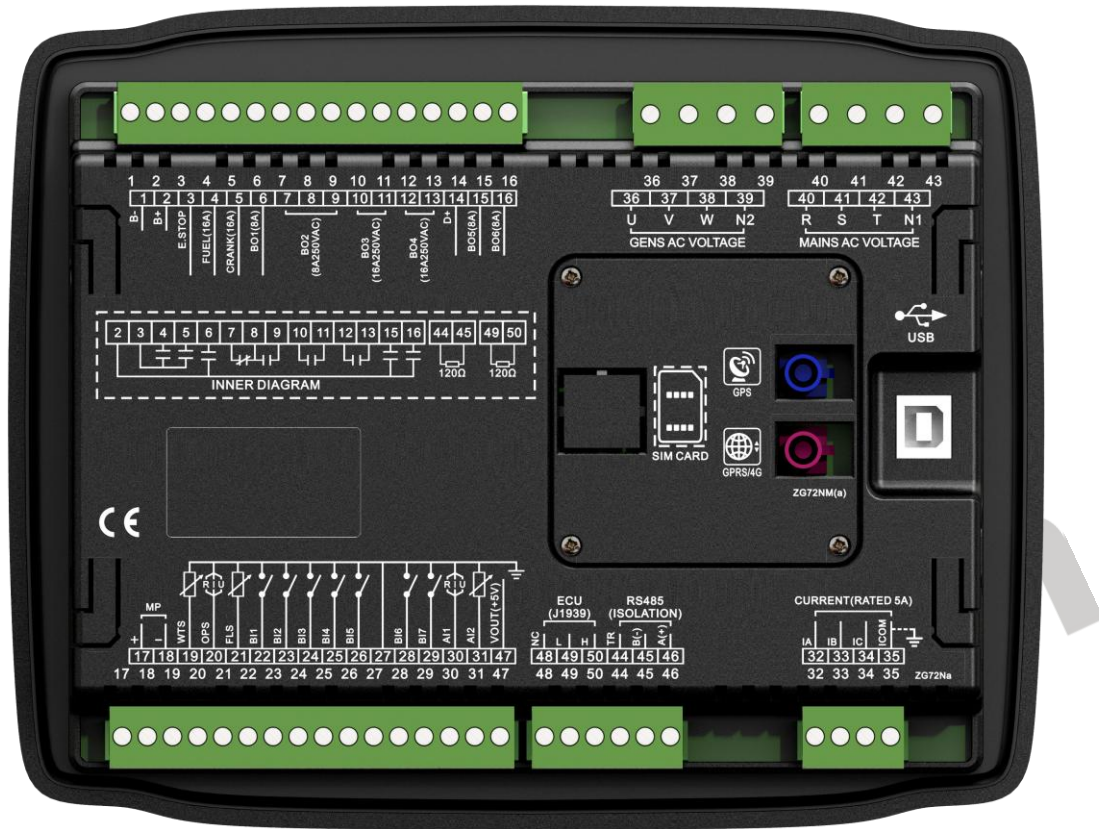

Figure 2 - Back Panel

Table 9 - Terminal Wiring Connection

| No. | Function | Cable Size | Remarks |
|-----|--|--|--|
| 1 | B- | 2.5mm ² | Connected with negative of starter battery. |
| 2 | B+ | 2.5mm ² | Connected with positive of starter battery. If wire length is over 30m, it's better to double wires in parallel. Max. 20A fuse is recommended. |
| 3 | Emergency Stop | 2.5mm ² | Connect with B+ via emergency stop button. |
| 4 | Fuel (16A) | 1.5mm ² | B+ is supplied by Terminal 3, rated 16A. |
| 5 | Crank (16A) | 1.5mm ² | B+ is supplied by Terminal 3, rated 16A. Connect with starting coil of starter. |
| 6 | Aux. Output 1(8A) | 1.5mm ² | B+ is supplied by Terminal 2, rated 8A. |
| 7 | Aux. Output 2(8A 250VAC) | 1.5 mm ² | NC output, rated 8A. |
| 8 | | | Relay common port. |
| 9 | | | NO output, rated 8A. |
| 10 | Aux. Output 3(16A 250VAC) | 2.5 mm ² | Relay NO volt free contact, rated 16A, volt free contact output. |
| 11 | | | |
| 12 | Aux. Output 4(16A 250VAC) | 2.5 mm ² | |
| 13 | | | |
| 14 | Charger(D+) | 1.0mm ² | Connected with charger starter's D+ (WL) terminal. Please hang it up if there is not this terminal. |
| 15 | Aux. Output 5(8A) | 1.5 mm ² | B+ is supplied by Terminal 2, rated 8A |
| 16 | Aux. Output 6(8A) | 1.5 mm ² | |
| 17 | Speed Sensor Input | | Connect with speed sensor, and shielded wire is recommended. |
| 18 | Speed sensor input, battery negative electrode has been connected inside controller. | | |
| 19 | Engine Temp. | Connect with temperature sensor | |
| 20 | Oil Pressure | Connect with pressure sensor | |
| 21 | Fuel Level | Connect with fuel level sensor | |
| 22 | Aux. Input 1 | 1.0mm ² | Ground connected is active (B-) |
| 23 | Aux. Input 2 | 1.0mm ² | Ground connected is active (B-) |
| 24 | Aux. Input 3 | 1.0mm ² | Ground connected is active (B-) |
| 25 | Aux. Input 4 | 1.0mm ² | Ground connected is active (B-) |
| 26 | Aux. Input 5 | 1.0mm ² | Ground connected is active (B-) |
| 27 | Sensor Common Port | Sensor common port, battery negative electrode has been connected inside controller. | |
| 28 | Aux. Input 6 | 1.0mm ² | Ground connected is active (B-) |
| 29 | Aux. Input 7 | 1.0mm ² | Ground connected is active (B-) |



| No. | Function | Cable Size | Remarks |
|-----|--|---|--|
| 30 | Configurable Sensor 1 | Connected with temp/pressure/fuel level sensor. | For items please see Table 13. |
| 31 | Configurable Sensor 2 | | |
| 32 | CT A-phase Monitoring Input | 1.5mm ² | Outside connected to secondary coil of CT (5A rated). |
| 33 | CT B-phase Monitoring Input | 1.5mm ² | Outside connected to secondary coil of CT (5A rated). |
| 34 | CTC-phase Monitoring Input | 1.5mm ² | Outside connected to secondary coil of CT (5A rated). |
| 35 | CT Common Port | 1.5mm ² | Details to see the following installation description. |
| 36 | Gen U-phase Voltage Monitoring Input | 1.0mm ² | Connected to U-phase output of genset (2A fuse recommended). |
| 37 | Gen V-phase Voltage Monitoring Input | 1.0mm ² | Connected to V-phase output of genset (2A fuse recommended). |
| 38 | Gen W-phase Voltage Monitoring Input | 1.0mm ² | Connected to W-phase output of genset (2A fuse recommended). |
| 39 | Gen N2-line Input | 1.0mm ² | Connected to N-line output of genset. |
| 40 | Mains R-phase Voltage Monitoring Input | 1.0mm ² | Connected to R-phase of mains (2A fuse recommended). |
| 41 | Mains S-phase voltage monitoring input | 1.0mm ² | Connected to S-phase of mains (2A fuse recommended). |
| 42 | Mains T-phase voltage monitoring input | 1.0mm ² | Connected to T-phase of mains (2A fuse recommended). |
| 43 | Mains line N1 Input | 1.0mm ² | Connected to N-line of mains. |
| 44 | Terminal Resistor (120Ω) | 0.5mm ² | If 120Ω resistor is needed, short connect 44 and 46. |
| 45 | RS485- | 0.5mm ² | 120Ω shielding wire is recommended with single end ground connected. |
| 46 | RS485+ | 0.5mm ² | |
| 47 | VOUT(+5V) | 0.5mm ² | Output DC +5V. |
| 48 | NC | | |
| 49 | ECU CAN L | 0.5mm ² | 120Ω shielding wire is recommended with single end ground connected. Between CAN L and CAN H there is already 120Ω resistor inside the controller. |
| 50 | ECU CAN H | 0.5mm ² | |

NOTE: USB ports in controller rear panel are programmable parameter ports, and users can directly configure the controller on PC.

NOTE: Modem expansion module can be connected from the rear panel.

8 SCOPES AND DEFINITIONS OF PROGRAMMABLE PARAMETERS

8.1 CONTENTS AND SCOPES OF PARAMETERS

Table 10 - Parameter Settings and Scope

| No. | Items | Range | Default | Description |
|----------------------|--------------------------|---------------|----------|--|
| Mains Setting | | | | |
| 1 | Mains Enable | (0-1) | 1 | 0: Disable; 1: Enable |
| 2 | AC System | (0-3) | 0 | 0: 3P4W; 1: 3P3W 2: 2P3W 3: 1P2W |
| 3 | Rated Voltage | (30-30000)V | 230 | Provide standard for judging mains over/under voltage or not; if voltage transformer is applied, this value is the primary voltage of transformer. |
| 4 | Rated Frequency | (10.0-75.0)Hz | 50.0 | Provide standard for judging mains over/under frequency or not. |
| 5 | Normal Time | (0-3600)s | 10 | The time from mains abnormal to normal. |
| 6 | Abnormal Time | (0-3600)s | 5 | The time from mains normal to abnormal. |
| 7 | Voltage Transformer (PT) | (0-1) | 0 | 0: Disabled; 1: Enabled |
| 8 | Over Voltage | (0-200)% | 120 | The setting value is mains rated voltage percentage; return value and delay value also can be set. |
| 9 | Under Voltage | (0-200)% | 80 | |
| 10 | Over Frequency | (0-200)% | Disabled | The setting value is mains rated frequency percentage; return value and delay value also can be set. |
| 11 | Under Frequency | (0-200)% | Disabled | |
| 12 | Loss of Phase Check | (0-1) | 1 | 0: Disabled; 1: Enabled |
| 13 | Reverse Phase | (0-1) | 1 | |
| Timer Setting | | | | |
| 1 | Start Delay | (0-3600)s | 1 | Time between mains abnormal or remote start signal is active and genset start. |
| 2 | Return Delay | (0-3600)s | 1 | Time between mains normal or remote start signal is deactivated and genset stop. |
| 3 | Preheat Delay | (0-3600)s | 0 | Power-on time of heater plug before starter is powered up. |
| 4 | Cranking Time | (3-60)s | 8 | Each starter power-on time |
| 5 | Crank Rest Time | (3-60)s | 10 | The waiting time before second power up when engine start fails. |
| 6 | Safety On Time | (0-3600)s | 10 | Alarms for low oil pressure, high temp, under speed, under frequency/voltage, charge alt failure are deactivated. |
| 7 | Start Idle Time | (0-3600)s | 0 | Running time for idling speed when genset starts up. |
| 8 | Warming Up Time | (0-3600)s | 10 | Warming up time for genset after entering high speed running before breaker close. |



| No. | Items | Range | Default | Description |
|-----------------------|------------------------------|-------------|---------|--|
| 9 | Cooling Time | (0-3600)s | 10 | Cooling time before genset stop after genset deloading. |
| 10 | Stop Idle Time | (0-3600)s | 0 | Running time for idling speed when genset stops. |
| 11 | ETS Hold Time | (0-3600)s | 20 | Time for ETS energization before genset stop. |
| 12 | Wait Stop Time | (0-3600)s | 0 | When "ETS Hold Time" is set 0, it is the time after idle delay and before complete stop. When "ETS Hold Time" is not 0, it is time after ETS stop delay before complete stop. |
| 13 | After Stop Time | (0-3600)s | 0 | Time from genset stop to standby status. |
| Engine Setting | | | | |
| 1 | Engine Type | (0-39) | 0 | Default: conventional engine. |
| 2 | Flywheel Teeth | (1.0-300.0) | 118 | It is tooth number of the engine, which is used for judging starter crank disconnect conditions and inspecting engine speed. For details please see the following installation description. |
| 3 | Rated Speed | (0-6000)RPM | 1500 | Provide standard for judging over/under speed and on-load speed. |
| 4 | Speed On-load | (0-100)% | 90 | The setting value is rated speed percentage. The controller detects it while gen-set prepares to take the load, if the speed is less than the on-load speed, gen-set will not enter normal operation period. |
| 5 | Speed Signal Loss Delay | (0-3600)s | 5 | Time from the speed is detected 0 to action confirmation. |
| 6 | Speed Signal Loss Action | (0-1) | 0 | 0: Warning; 1: Shutdown |
| 7 | Over Speed Shutdown | (0-200)% | 114 | The setting value is the percentage of rated speed, and delay value can be set. |
| 8 | Under Speed Shutdown | (0-200)% | 80 | |
| 9 | Over Speed Warning | (0-200)% | 110 | The setting value is the percentage of rated speed, return value and delay value can be set. |
| 10 | Under Speed Warning | (0-200)% | 86 | |
| 11 | Battery Rated Voltage | (0-60.0)V | 24.0 | Provide standard for judging battery over/under voltage. |
| 12 | Battery High Voltage Warning | (0-200)% | 120 | The setting value is the percentage of rated voltage, return value and delay value can be set. |
| 13 | Battery Low Voltage Warning | (0-200)% | 85 | |
| 14 | Charge Alt Fail | (0-60.0)V | 8.0 | If the voltage of charger D+(WL) is lower than the setting value during gen-set normal running, controller will initiate "Charge Alt Fail" warning. |



| No. | Items | Range | Default | Description |
|--------------------------|--------------------------------------|-------------|---------|---|
| 15 | Start Attempts | (1-10)times | 3 | Maximum crank times when engine start fails. If it reaches this number, controller will send start failure signals. |
| 16 | Crank Disconnect Condition | (0-6) | 2 | For details please see table 14. There are 3 cranking disconnect conditions, which can be used separately or together, aiming to disconnect starter motor with engine as soon as possible. |
| 17 | Frequency of Crank Disconnect | (0-200)% | 24 | The setting value is the percentage of rated frequency, when generator frequency is higher than the set value, starter will be disconnected. For details please see the following installation description. |
| 18 | Speed of Crank Disconnect | (0-200)% | 24 | The setting value is the percentage of the rated speed, when speed is higher than the setting value, starter will disconnect. Details to see the following installation description. |
| 19 | Oil Pressure of Crank Disconnect | (0-1000)kPa | 200 | When engine oil pressure is higher than the setting value, starter will disconnect. For details please see the following installation description. |
| 20 | Battery Low Voltage Start Enabled | (0-1) | 0 | 0: Disabled; 1:Enabled |
| 21 | Battery Low Voltage Start Value | (1.0-60.0)V | 10.0 | It is the low-battery-start value. It is active when in auto mode. |
| 22 | Battery Low Voltage Stop Value | (1.0-60.0)V | 24.0 | The shutdown value after genset start and being charged. Active when it is in auto mode. |
| 23 | Battery Low Voltage Start/Stop Delay | (0-3600)s | 60 | When battery voltage reached to engine start limit, engine will start up after delay is expired; when battery voltage reached to engine stop limit, engine will stop after delay is expired. |
| Generator Setting | | | | |
| 1 | Power System Supply | (0-3) | 0 | 0: 3P4W; 1: 3P3W 2: 2P3W 3: 1P2W |
| 2 | Engine Poles | (2-64) | 4 | It is the number of engine poles, which can help engine without installing speed sensor to calculate engine speed. |
| 3 | Rated Voltage | (30-30000)V | 230 | Provide standard for judging gen over/under voltage, and on-load voltage. If voltage transformer is used, this value is transformer primary voltage. |



| No. | Items | Range | Default | Description |
|-------------|-------------------------------|-----------------|---------|--|
| 4 | Voltage On-load | (0-200)% | 85 | The set value is rated voltage percentage. The controller detects it while gen-set prepares to take the load, if voltage is less than the on-load voltage, gen-set will not enter normal operation period. |
| 5 | Rated Frequency | (10.0-600.0) Hz | 50.0 | Provide standard for judging over/under frequency and on-load frequency. |
| 6 | Frequency On-load | (0-200)% | 85 | The set value is rated frequency percentage. The controller detects it while genset prepares to take the load, if frequency is less than the on-load frequency, genset will not enter normal operation period. |
| 7 | Voltage Transformer (PT) | (0-1) | 0 | 0: Disabled; 1: Enabled |
| 8 | Gen. Over Voltage Shutdown | (0-200)% | 120 | The set values are rated voltage percentage of generator, and delay value can be set. |
| 9 | Gen. Under Voltage Shutdown | (0-200)% | 80 | |
| 10 | Gen. Over Frequency Shutdown | (0-200)% | 114 | The set values are rated frequency percentage of generator, and delay value can be set. |
| 11 | Gen. Under Frequency Shutdown | (0-200)% | 80 | |
| 12 | Gen. Over Voltage Warning | (0-200)% | 110 | The set values are rated voltage percentage of generator, and return value and delay value can be set. |
| 13 | Gen. Under Voltage Warning | (0-200)% | 84 | |
| 14 | Gen. Over Frequency Warning | (0-200)% | 110 | The set values are rated frequency percentage of generator, and return value and delay value can be set. |
| 15 | Gen. Under Frequency Warning | (0-200)% | 84 | |
| 16 | Gen. Loss of Phase Check | (0-1) | 1 | 0: Disabled; 1:Enabled |
| 17 | Gen. Reverse Phase Check | (0-1) | 1 | |
| Load | | | | |
| 1 | Current Transformer Ratio | (5-6000)/5 | 500 | It is the ratio of external connected current transformer. |
| 2 | Rated Current | (5-6000)A | 500 | It is the rated current of generator, which is used as the standard for load current. |
| 3 | Rated Power | (0-6000)kW | 276 | It is the rated power of generator, which is used as the standard for load current. |
| 4 | Over Current Enable | (0-200)% | 120 | The setting value is the percentage of rated full-load current, and delay value can be set as DMT or IDMT. |
| 5 | Over Power Setting | (0-1) | 0 | 0: Disabled; 1: Enabled |



| No. | Items | Range | Default | Description |
|-----------------------|-------------------------------------|------------|---------|--|
| 6 | Reverse Power Setting | (0-1) | 0 | 0: Disabled; 1: Enabled |
| Load Setting | | | | |
| 1 | Current Transform | (5-6000)/5 | 500 | Changes of Externally connected CT. |
| 2 | Rated Current | (5-6000)A | 500 | Generator rated current, standard for load current. |
| 3 | Rated Power | (0-6000)kW | 276 | Generator rated power, standard for load power. |
| 4 | Over Current Enable and Value | (0-200)% | 120 | The set value is rated current percentage. Return value can be set as timing limit or reverse limit. Actions are warning, shutdown, trip and shutdown, and trip. |
| 5 | Reverse Power | (0-1) | 0 | 0: Disable 1: Enable |
| 6 | Over Power | (0-1) | 0 | 0: Disable 1: Enable |
| Switch Setting | | | | |
| 1 | Switching Time | (0-7200)s | 5 | Internal time for from mains open to gens close, or from gens open to mains close. |
| 2 | Close Delay | (0-20.0)s | 5.0 | Pulse width of mains close and generator close; 0 stands for constant output. |
| 3 | Open Delay | (0-20.0)s | 3.0 | Pulse width of mains open and generator open. |
| 4 | Switching Detection Time | (0-20.0)s | 5.0 | It is the time to detect auxiliary contactor after ATS switching. |
| 5 | Switch Failure Warning Enabled | (0-1) | 0 | 0: Disabled; 1: Enabled |
| 6 | Open Detection Enabled | (0-1) | 0 | |
| 7 | Immediately Trip when Mains Dropout | (0-1) | 1 | 0: Disabled; 1: Enabled |
| 8 | Sync Enable | (0-1) | 1 | 0: Disabled; 1: Enabled |
| 9 | Check Volt | (0-1) | 0 | 0: Disabled; 1: Enabled |
| 10 | Check Sync Volt | (0-50) V | 5 | Voltage difference between gens and mains, if the value is below this, then voltage sync. is recognized. |
| 11 | Check Sync Freq | (0-2) Hz | 0.2 | Frequency difference between gens and mains, if the value is below this, then frequency sync. is recognized. |
| 12 | Check Phase Ang | (0-20)° | 5 | Phase difference between gens and mains, if the value is below this, then phase sync. is recognized. |
| 13 | Fail to Sync Action | (0-1) | 0 | 0: Warning 1: Trip |
| 14 | Transfer in Sync Fail | (0-1) | 1 | 0: Disabled; 1: Enabled |



| No. | Items | Range | Default | Description |
|---|--------------------------------|-------------|---------|---|
| 15 | Fail Sync Delay | (0-3600)s | 120 | The max. waiting sync. time; if time is due and still meets the sync. conditions, then sync. failure alarm is issued. |
| 16 | Sync. Detection Time | (0.1-1.0) s | 0.6 | During sync. changeover, sync. close or open output delay starts, during the delay if correct close/open status is detected, then close/open pulse output is stopped; if when the delay is over, the correct close/open status is not detected, then transfer failure trip alarm shall be issued. NOTE: if detection time is less than breaker C/O time, then detection time is C/O time. |
| Module Setting | | | | |
| 1 | Power On Mode | (0-2) | 0 | 0: Stop Mode; 1: Manual Mode; 2: Auto Mode |
| 2 | Slave ID | (1-254) | 1 | Controller address in remote monitoring status. |
| 3 | Communication Stop-bit Setting | (0-1) | 1 | 0: 2-bit stop bit; 1: 1-bit stop bit |
| 4 | Language | (0-2) | 0 | 0: Simplified Chinese; 1: English; 2: Other |
| 5 | Password | (0-65535) | 00318 | This password is used to enter advanced parameter setting. |
| 6 | LCD Light Time | (0-3600)s | 300 | When it is 0s, LCD always is light. |
| Schedule & Maintenance Setting | | | | |
| 1 | Scheduler Run | (0-1) | 0 | 0: Disabled; 1: Enabled |
| 2 | Scheduler Not Run | (0-1) | 0 | 0: Disabled; 1: Enabled |
| 3 | Maintenance | (0-1) | 0 | 0: Disabled; 1: Enabled |
| Analog Sensor Setting | | | | |
| Temperature Sensor | | | | |
| 1 | Curve Type | (0-15) | 7 | SGX. For details please see Table 13. |
| 2 | Open Circuit Action | (0-2) | 0 | 0: Warning; 1: Shutdown; 2: None |
| 3 | High Temp Shutdown | (-50-300)°C | 98 | When externally connected temperature sensor value is higher than the set point, controller will initiate high temperature shutdown alarm. It is only judged after "safety on delay" is over. Delay value can be set. |



| No. | Items | Range | Default | Description |
|----------------------------|---------------------------|-------------|---------|---|
| 4 | High Temp Warning | (-50-300)°C | 95 | When externally connected temperature sensor value is higher than the set point, controller will initiate high temperature warning alarm. It is only judged after "safety on delay" is over. Return value and delay value can be set. |
| 5 | Low Temp Warning | (0-1) | 0 | 0: Disabled; 1: Enabled |
| Oil Pressure Sensor | | | | |
| 1 | Curve Type | (0-15) | 7 | SGX. For details please see table 13. |
| 2 | Open Circuit Action | (0-2) | 0 | 0: Warning; 1: Shutdown; 2: None |
| 3 | Low Oil Pressure Shutdown | (0-1000)kPa | 103 | When externally connected oil pressure sensor value is lower than the set point, controller will initiate low oil pressure shutdown alarm. It is only judged after "safety on delay" is over. Delay value can be set. |
| 4 | Low Oil Pressure Warning | (0-1000)kPa | 124 | When externally connected oil pressure sensor value is lower than the set point, controller will initiate low oil pressure warning alarm. It is only judged after "safety on delay" is over. Return value and delay value can be set. |
| 5 | Sensor Type | (0-2) | 0 | 0: Resistor type; 1: Current type; 2: Voltage type. |
| Level Sensor | | | | |
| 1 | Curve Type | (0-15) | 4 | SGH. For details please see table 13. |
| 2 | Open Circuit Action | (0-2) | 0 | 0: Warning; 1: Shutdown; 2: None |
| 3 | Low Level Warning | (0-300)% | 10 | When the value of externally connected fuel level sensor is lower than the set point, controller will initiate low liquid level warning alarm. It is always judged. Return value and delay value can be set. |
| 4 | Low Level Shutdown | (0-300)% | 8 | When the value of external connected level sensor is lower than the set point, controller will initiate low liquid level shutdown alarm. It is always judged. Delay value can be set. |
| Flexible Sensor 1 | | | | |
| 1 | Flexible Sensor 1 | (0-3) | 0 | 0: Not Used; 1:Temperature Sensor; 2:Pressure Sensor; 3:Fuel Level Sensor |
| 2 | Sensor Type | (0-2) | 0 | 0: Resistor type; 1: Current type; 2: Voltage type. |
| Flexible Sensor 2 | | | | |
| 1 | Flexible Sensor 2 | (0-3) | 0 | 0: Not Used; 1:Temperature Sensor; 2:Pressure Sensor; 3:Fuel Level Sensor |
| Digital Inputs | | | | |
| Digital Input 1 | | | | |
| 1 | Content Setting | (0-50) | 28 | Remote start (on-load). For details please see table 12. |

| No. | Items | Range | Default | Description |
|-----------------|-----------------|-----------|---------|---|
| 2 | Active Type | (0-1) | 0 | 0: Close; 1: Open |
| Digital Input 2 | | | | |
| 1 | Content Setting | (0-50) | 26 | High temperature shutdown input. For details please see table 12. |
| 2 | Active Type | (0-1) | 0 | 0: Close; 1: Open |
| Digital Input 3 | | | | |
| 1 | Content Setting | (0-50) | 27 | Low oil pressure shutdown input. For details please see table 12. |
| 2 | Active Type | (0-1) | 0 | 0: Close; 1: Open |
| Digital Input 4 | | | | |
| 1 | Content Setting | (0-50) | 0 | HGM7220N controller: User-defined. For details please see table 12. |
| | | | 13 | HGM7220S controller: Gens close status input. For details please see table 12. |
| 2 | Active Type | (0-1) | 0 | 0: Close; 1: Open |
| 3 | Active Range | (0-3) | 2 | 0: From safety on delay; 1: From crank; 2: Always; 3:Never |
| 4 | Active Action | (0-4) | 0 | 0: Warning; 1: Shutdown; 2: Trip and Stop; 3: Trip; 4: Indication. |
| 5 | Active Delay | (0-20.0)s | 2.0 | Time from detecting input port is active to confirmation. |
| 6 | Description | | | LCD displays corresponding content when input port is active. |
| Digital Input 5 | | | | |
| 1 | Content Setting | (0-50) | 0 | HGM7220N controller: User-defined. For details please see table 12. |
| | | | 13 | HGM7220S controller: Mains close status input. For details please see table 12. |
| 2 | Active Type | (0-1) | 0 | 0: Close; 1: Open |
| 3 | Active Range | (0-3) | 2 | 0: From safety on delay; 1: From crank; 2: Always; 3:Never |
| 4 | Active Action | (0-4) | 1 | 0: Warning; 1: Shutdown; 2: Trip and Stop; 3: Trip; 4: Indication. |
| 5 | Active Delay | (0-20.0)s | 2.0 | Time from detecting input port is active to confirmation. |
| 6 | Description | | | LCD displays corresponding content when input port is active. |
| Digital Input 6 | | | | |
| 1 | Content Setting | (0-50) | 0 | User defined. For details please see table 12. |
| 2 | Active Type | (0-1) | 0 | 0: Close; 1: Open |
| 3 | Active Range | (0-3) | 2 | 0: From safety on delay; 1: From crank; 2: Always; 3:Never |
| 4 | Active Action | (0-4) | 2 | 0: Warning; 1: Shutdown; 2: Trip and Stop; 3: Trip; 4: Indication. |
| 5 | Active Delay | (0-20.0)s | 2.0 | Time from detecting input port is active to confirmation. |

| No. | Items | Range | Default | Description |
|-----------------------------|----------------------|-----------|---------|--|
| 6 | Description | | | LCD displays corresponding content when input port is active. |
| Digital Input 7 | | | | |
| 1 | Content Setting | (0-50) | 0 | User defined. For details please see table 12. |
| 2 | Active Type | (0-1) | 0 | 0: Close; 1: Open |
| 3 | Active Range | (0-3) | 2 | 0: From safety on delay; 1: From crank; 2: Always; 3:Never |
| 4 | Active Action | (0-4) | 3 | 0: Warning; 1: Shutdown; 2: Trip and Stop; 3: Trip; 4: Indication. |
| 5 | Active Delay | (0-20.0)s | 2.0 | Time from detecting input port is active to confirmation. |
| 6 | Description | | | LCD displays corresponding content when input port is active. |
| Relay Output Setting | | | | |
| Relay Output 1 | | | | |
| 1 | Content Setting | (0-239) | 1 | User defined time period output 1(default: output in preheat period). For details please see table 11. |
| 2 | Output Type | (0-1) | 0 | 0: Normally open; 1: Normally close. |
| Relay Output 2 | | | | |
| 1 | Content Setting | (0-239) | 35 | Idle speed control. For details please see table 11. |
| 2 | Output Type | (0-1) | 0 | 0: Normally open; 1: Normally close. |
| Relay Output 3 | | | | |
| 1 | Content Setting | (0-239) | 29 | Close generator output. For details please see table 11. |
| 2 | Output Type | (0-1) | 0 | 0: Normally open; 1: Normally close. |
| Relay Output 4 | | | | |
| 1 | Content Setting | (0-239) | 31 | Close mains output. For details please see table 11. |
| 2 | Output Type | (0-1) | 0 | 0: Normally open; 1: Normally close. |
| Relay Output 5 | | | | |
| 1 | Content Setting | (0-239) | 38 | ETS control. For details please see table 11. |
| 2 | Output Type | (0-1) | 0 | 0: Normally open; 1: Normally close. |
| Relay Output 6 | | | | |
| 1 | Content Setting | (0-239) | 48 | Common alarm. For details please see table 11. |
| 2 | Output Type | (0-1) | 0 | 0: Normally open; 1: Normally close. |
| Cycle Start Setting | | | | |
| 1 | Cycle Start Enable | (0-1) | 0 | 0: Disabled; 1: Enabled |
| 2 | Priority Selection | (0-1) | 0 | 0: standby unit (slave unit); 1: Main unit |
| 3 | Master Running (min) | (0-1440) | 720 | |
| 4 | Obey Running (min) | (0-1440) | 720 | |

| No. | Items | Range | Default | Description |
|-----------------------------|-----------------|--|---|---|
| SGE02-4G Setting | | | | |
| 1 | SGE02-4G Enable | (0-1) | 1 | 0: Disabled; 1: Enabled |
| 2 | SMS Enable | (0-1) | 0 | 0: Disabled; 1: Enabled |
| 3 | Mobile Number | Max. 20 bits | All numbers are needed to add district or country number, e.g. China 13666666666. | |
| 4 | GPRS Enable | (0-1) | 1 | 0: Disabled; 1: Enabled |
| 5 | GPS Enable | (0-1) | 1 | 0: Disabled; 1: Enabled |
| 6 | Longitude | (-180-180)° | 113.33 | When GPS is disabled, monitor module GPS position and altitude information can be inputted. |
| 7 | Latitude | (-90-90)° | 34.48 | |
| 8 | Altitude | (-9999.9-9999.9)m | 100 | |
| Cloud Server Setting | | | | |
| 1 | Site Name | 20 characters/40 letters/40 numbers | | |
| 2 | URL Server | www.monitoryun.com | | |
| 3 | Server Port | (0-65535) | 91 | |
| 4 | Module Password | 123456 | | 16 characters |

8.2 DEFINITION CONTENT OF PROGRAMMABLE OUTPUT PORTS 1~6

Table 11 - Programmable Output Ports 1~6

| No. | Type | Description |
|-----|-------------------|---|
| 0 | Not Used | |
| 1 | Custom Period 1 | For details about function description please see the following content. |
| 2 | Custom Period 2 | |
| 3 | Custom Period 3 | |
| 4 | Custom Period 4 | |
| 5 | Custom Period 5 | |
| 6 | Custom Period 6 | |
| 7 | Custom Combined 1 | |
| 8 | Custom Combined 2 | |
| 9 | Custom Combined 3 | |
| 10 | Custom Combined 4 | |
| 11 | Custom Combined 5 | |
| 12 | Custom Combined 6 | |
| 13 | Reserved | |
| 14 | Reserved | |
| 15 | Reserved | |
| 16 | Reserved | |
| 17 | Air Flap Control | It is activated when over speed shutdown and emergency shutdown alarms occur, which can turn off the engine intake. |
| 18 | Audible Alarm | It is activated when warning, shutdown and electrical trip alarms appear. Annunciator can be connected externally; if aux. input port is configured as "Mute Alarms" and if it is |



| No. | Type | Description |
|-----|----------------------|---|
| | | active, audible alarm can be inhibited. |
| 19 | Louver Control | It is activated from starting generator and disconnected after generator's complete stop. |
| 20 | Fuel Pump Control | It is controlled by the upper/lower limits of the sensor fuel pump. |
| 21 | Heater Control | It is controlled by the upper/lower limits of the sensor heater. |
| 22 | Cooler Control | It is controlled by the upper/lower limits of the sensor cooling. |
| 23 | Pre- fuel | Activated from cranking to safety on period. |
| 24 | Excite Generator | Output while in cranking, if there is not generator frequency in high speed running status, then output again for 2s. |
| 25 | Pre-lubricate Output | Activated from pre-heat to safety on period. |
| 26 | Remote PC Output | Through communication (PC) to control this output port. |
| 27 | Reserved | |
| 28 | Reserved | |
| 29 | Close Generator | Controlling breaker to make generator takes on load. |
| 30 | Open Breaker | HGM7220N: Controlling breaker to ramp off load. |
| | Open Generator | HGM7220S: Controlling generator breaker to ramp off load. |
| 31 | Close Mains | Controlling breaker to make mains take on load. |
| 32 | Reserved | HGM7220N: Reserved. |
| | Open Mains | HGM7220S: Controlling mains breaker to ramp off load. |
| 33 | Starter Relay Output | |
| 34 | Fuel Relay Output | Activated when generator starts, and disconnected while ETS starts. |
| 35 | Idle Control | Used for engine with idle speed function. It closes before starting up and opens when controller enters hi-speed warming up; it closes during stop idling process and opens when stop is completed. |
| 36 | Raise Speed | Activated in high-speed warming up period. |
| 37 | Drop Speed | Activated from generator stop idling to waiting for stop. |
| 38 | ETS Control | Suitable for gen-set with electromagnet and activated after "stop idle delay". It is deactivated when "ETS Solenoid delay" expires. |
| 39 | Pulse Drop Speed | |
| 40 | ECU Stop | Suitable for engine with ECU injection to control ECU stop. |
| 41 | ECU Power | Suitable for engine with ECU injection to control ECU power. |
| 42 | Pulse Raise Speed | |
| 43 | Crank Success | Connect when crank disconnect signal is detected. |
| 44 | Generator OK | Activated when generator is OK. |
| 45 | Generator Available | Activated from generator normal running to hi-speed cooling. |
| 46 | Mains OK | Activated when mains is OK. |
| 47 | Loading Speed Output | |
| 48 | Common Alarm | Activated when common warning, common shutdown and common trip alarms occur. |



| No. | Type | Description |
|-------|------------------------|--|
| 49 | Common Ele Trip | Activated when common electrical trip and stop occurs. |
| 50 | Common Shutdown | Activated when common shutdown occurs. |
| 51 | Common Trip Alarm | Activated when common trip alarms occur. |
| 52 | Common Warn Alarm | Activated when common warnings occur. |
| 53 | Reserved | |
| 54 | Battery High Voltage | Activated when battery voltage is over too high. |
| 55 | Battery Low Voltage | Activated when battery voltage is over too low. |
| 56 | Charge Alt Fail | Activated when generator “fail to charge” alarms occur. |
| 57 | Reserved | HGM7220N: Reserved. |
| | Sync Indication | HGM7220S: Output when sync. conditions are satisfied. |
| 58 | Reserved | |
| 59 | Reserved | |
| 60 | ECU Warn Alarm | It is indicated that ECU sends a warning alarm signal. |
| 61 | ECU Shutdown Alarm | It is indicated that ECU sends a shutdown alarm signal. |
| 62 | ECU Com. Fail | In case ECU is selected for engine type, it is activated when speed signal is not received from “start idle” to “stop idle”. |
| 63 | Reserved | |
| 64 | Reserved | |
| 65 | Reserved | |
| 66 | Reserved | |
| 67 | Reserved | |
| 68 | Reserved | |
| 69 | Digital Input 1 Active | Activated when input port 1 is active. |
| 70 | Digital Input 2 Active | Activated when input port 2 is active. |
| 71 | Digital Input 3 Active | Activated when input port 3 is active. |
| 72 | Digital Input 4 Active | Activated when input port 4 is active. |
| 73 | Digital Input 5 Active | Activated when input port 5 is active. |
| 74 | Digital Input 6 Active | Activated when input port 6 is active. |
| 75 | Digital Input 7 Active | Activated when input port 7 is active. |
| 76-98 | Reserved | |
| 99 | Emergency Stop Alarm | Activated when emergency stop alarm occurs. |
| 100 | Failed to Start Alarm | Activated when “fail to start” alarm occurs. |
| 101 | Failed to Stop Alarm | Activated when “fail to stop” warning occurs. |
| 102 | Under Speed Warning | Activated when engine under speed warning occurs. |
| 103 | Under Speed Shutdown | Activated when engine under speed shutdown occurs. |
| 104 | Over Speed Warning | Activated when engine over speed warning alarm occurs. |
| 105 | Over Speed Shutdown | Activated when over speed shutdown alarms occur. |
| 106 | Reserved | |
| 107 | Reserved | |
| 108 | Reserved | |
| 109 | Gen. Over Freq Warning | Activated when generator over frequency warning alarm occurs. |



| No. | Type | Description |
|---------|----------------------------------|---|
| 110 | Gen. Over Freq Shutdown | Activated when generator over frequency shutdown alarm occurs. |
| 111 | Gen. Over Voltage Warning | Activated when generator over voltage warning alarm occurs. |
| 112 | Gen. Over Volt Shutdown | Activated when generator over voltage shutdown alarm occurs. |
| 113 | Gen. Under Frequency Warning | Activated when generator under frequency warning alarm occurs. |
| 114 | Gen. Under Frequency Shutdown | Activated when generator under frequency shutdown alarm occurs. |
| 115 | Gen. Under Voltage Warning | Activated when generator under voltage warning alarm occurs. |
| 116 | Gen. Under Voltage Shutdown | Activated when generator under voltage shutdown alarm occurs. |
| 117 | Gen. Loss of Phase | Activated when generator loss of phase alarm occurs. |
| 118 | Gen. Reverse Phase | Activated when generator phase sequence wrong alarm occurs. |
| 119 | Reserved | |
| 120 | Over Power Alarm | |
| 121 | Reserved | |
| 122 | Reverse Power | Activated when controller detects that generator power is reversed. |
| 123 | Over Current Alarm | Activated when over current occurs. |
| 124 | Reserved | |
| 125 | Mains Inactive | |
| 126 | Mains Over Frequency | |
| 127 | Mains Over Voltage | |
| 128 | Mains Under Frequency | |
| 129 | Mains Under Voltage | |
| 130 | Mains Reverse Phase | |
| 131 | Mains Loss Of Phase | |
| 132-138 | Reserved | |
| 139 | High Temp Warning | Activated when high temperature warning alarms occurs. |
| 140 | Low Temp Warning | Activated when low temperature warning alarms occurs. |
| 141 | High Temp Shutdown Alarm | Activated when high temperature shutdown alarms occurs. |
| 142 | Reserved | |
| 143 | Low Oil Pressure Warning | Activated when low oil pressure warning alarms occurs. |
| 144 | Low Oil Pressure Shutdown | Activated when low oil pressure shutdown alarms occurs. |
| 145 | Oil Pressure Sensor Open Circuit | Activated when oil pressure open circuit alarms occurs. |
| 146 | Reserved | |
| 147 | Low Level Warning | Activated when low fuel level alarms occurs. |
| 148 | Reserved | |



| No. | Type | Description |
|---------|--------------------------------|---------------------------------------|
| 149 | Reserved | |
| 150 | Config. Sensor 1 High Warning | |
| 151 | Config. Sensor 1 Low Warning | |
| 152 | Config. Sensor 1 High Shutdown | |
| 153 | Config. Sensor 1 Low Shutdown | |
| 154 | Config. Sensor 2 High Warning | |
| 155 | Config. Sensor 2 Low Warning | |
| 156 | Config. Sensor 2 High Shutdown | |
| 157 | Config. Sensor 2 Low Shutdown | |
| 158-229 | Reserved | |
| 230 | System In Stop Mode | Activated when system in stop mode. |
| 231 | System In Manual Mode | Activated when system in manual mode. |
| 232 | Reserved | |
| 233 | System In Auto Mode | Activated when system in auto mode. |
| 234 | Generator On Load Indication | |
| 235 | Mains On Load Indication | |
| 236 | Reserved | |
| 237 | Reserved | |
| 238 | Reserved | |
| 239 | Reserved | |

8.2.1. CUSTOM PERIOD OUTPUT

Defined Period output is composed by 2 parts, **period output S1** and **condition output S2**.



While **S1** and **S2** are **TRUE** synchronously, **OUTPUT**;

While **S1** or **S2** is **FALSE**, **NOT OUTPUT**.

Period output S1 can set generator's one or more period output freely, can set the delayed time and output time after enter into period.

Condition output S2 can set as any conditions in output ports.

NOTE: when delay time and output time both are 0 in period output S1, it is TRUE in this period.

NOTE: when selected period is standby, it is cycle output and other periods are single output.

Example,

Output period: start

Delay output time: 2s

Output time: 3s

Condition output contents: output port 1 is active.

Close when condition output active/inactive: close when active (disconnect when inactive);

Output port 1 active, after enter "starts time" and delay 2s, this defined period output is outputting, after 3s, stop outputting;

Output port 1 inactive, defined output period is not outputting.

8.2.2. CUSTOM COMBINED OUTPUT

Defined combination output is composed by 3 parts, condition output S1 or S2 and condition output S3.

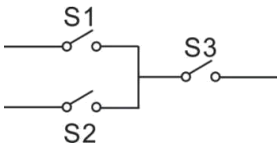

S1 or S2 is **TRUE**, while S3 is **TRUE**, defined combination output is outputting;

S1 and S2 are **FALSE**, or S3 is **FALSE**, defined combination output is not outputting.

NOTE: S1, S2, S3 can be set as any contents except for “defined combination output” in the output setting.

NOTE: 3 parts of defined combination output (S1, S2, and S3) couldn’t include or recursively include themselves.

Example,

Contents of probably condition output S1: output port 1 is active;

Close when probably condition output S1 is active /inactive: close when active (disconnect when inactive);

Contents of probably condition output S2, output port 2 is active;

Close when probably condition output S2 is active /inactive: close when active (disconnect when inactive);

Contents of probably condition output S3: output port 3 is active;

Close when probably condition output S3 is active /inactive: close when active (disconnect when inactive);

When input port 1 active or input port 2 active, if input port 3 is active, Defined combination output is outputting; If input port 3 inactive, Defined combination output is not outputting;











When input port 1 inactive and input port 2 inactive, whatever input port 3 is active or not, Defined combination output is not outputting.

8.3 DEFINED CONTENTS OF CONFIGURABLE INPUT PORTS 1~7

Table 12 - Programmable Inputs 1~7 (Ground connected is active (B-))

| No | Items | Description |
|----|-----------------|--|
| 0 | User Configured | Users can define contents as bellow: Indication: only display without warning and shutdown. Warning: only warning without shutdown. Shutdown: alarm and shutdown immediately. Trip and stop: alarm, generator ramp-off load and stop after high-speed cooling. Trip: alarm, generator ramp-off load but not stop. Inactive: input doesn't work. Always active: input detects all the time. Active from crank: start detecting at the beginning of startup. Active from safety on: detecting after safety on delay is expired. |
| 1 | Reserved | |
| 2 | Alarm Mute | When input is active, “Audible Alarm” output is inhibited. |
| 3 | Reset Alarm | When input is active, shutdown alarms and trip alarms can be reset. |
| 4 | 60Hz Select | Used for ECU engine with CANBUS, and it is 60Hz when active. |



| No | Items | Description |
|----|---------------------------|---|
| 5 | Lamp Test | When input is active, all LED indicators are light. |
| 6 | Panel Lock | When input is active, all buttons on the panel are inactive except for     , and  displays on the right side of the first line of LCD status page. |
| 7 | Reserved | |
| 8 | Idle Control Mode | Under speed, under frequency and under voltage are not protected in this mode. |
| 9 | Inhibit Auto Stop | After generator is normal running in auto mode, when input is active, generator-set auto stop function is inhibited. |
| 10 | Inhibit Auto Start | After input is active in auto mode, generator-set auto start is inhibited. |
| 11 | Inhibit Scheduled Start | After input is active in auto mode, generator-set auto timing start gen-set is inhibited. |
| 12 | Master Select | Duty unit selection in cycle running. |
| 13 | Aux. Gen. Closed | Connecting the auxiliary contactor of generator loading switch. |
| 14 | Inhibit Gen. Load | When input is active, gen-set will inhibit to close. |
| 15 | Aux Mains Closed | Connecting the auxiliary contactor of mains loading switch. |
| 16 | Inhibit Mains Load | When input is active, mains will inhibit to close. |
| 17 | Auto Mode Input | When input is active, controller will enter into auto mode, and all buttons on the panel are inactive except for     , and  displays on the right side of the first line of LCD status page. |
| 18 | Auto Mode Invalid | When input is active, controller will not work in auto mode,  key and “Simulate Auto Mode” key are unavailable. |
| 19 | Reserved | |
| 20 | Reserved | |
| 21 | Inhibit Alarm Shutdown | All shutdown alarms are inhibited except for emergency stop (sometimes called War Mode or Override Mode) |
| 22 | Instrument Mode | All outputs are inhibited in this mode. |
| 23 | Box Temp High Warning | |
| 24 | Reset Maintenance Time | When input is active, controller will reset maintenance time and date as pre-set values. |
| 25 | Low Level Shutdown | Connecting with sensor digital input. |
| 26 | High Temp Shutdown | Connecting with sensor digital input. |
| 27 | Low Oil Pressure Shutdown | Connecting with sensor digital input. |
| 28 | Remote Start (On-load) | When input is active in auto mode, gen-set will be started automatically, and then gen-set takes on load after normal running. When input is inactive, gen-set will be stopped automatically. |
| 29 | Remote Start (Off-load) | When input is active in auto mode, gen-set will be started automatically without taking load after normal running. When input |



| No | Items | Description |
|----|-----------------------------|---|
| | | is inactive, gen-set will be stopped automatically. |
| 30 | Aux Manual Start | When input is active in manual mode, gen-set will be started automatically. When input is inactive, gen-set will be stopped automatically. |
| 31 | Simulate Up Key | Externally connecting a button to simulate key function on the panel. |
| 32 | Simulate Down Key | |
| 33 | Simulate Stop Key | |
| 34 | Simulate Manual Key | |
| 35 | Reserved | |
| 36 | Simulate Auto Key | Externally connecting a button to simulate key function on the panel. |
| 37 | Simulate Start Key | |
| 38 | Simulate Gen C/O Key | |
| 39 | Simulate Mains C/O Key | |
| 40 | Rise Speed Pulse In | When engine type is 35 MTSC1 and is active, the pointed engine speed increases 50RPM. |
| 41 | Drop Speed Pulse In | When engine type is 35 MTSC1 and is active, the pointed engine speed decreases 50RPM. |
| 42 | Idle Pulse Input | When engine type is 35 MTSC1 and is active, the pointed engine speed goes to 800RPM. |
| 43 | Simulate Set Key | Externally connecting a button to simulate key function on the panel. |
| 44 | Simulate Return Key | |
| 45 | Simulate Mains OK | In auto mode if input is active, then mains is OK. |
| 46 | Simulate Mains Fail | In auto mode if input is active, then mains is abnormal. |
| 47 | Alternative Config 1 Active | When input port is active, alternative configuration is available. Alternative configuration can be set as different parameters, which is convenient to select current configuration via input ports. |
| 48 | Alternative Config 2 Active | |
| 49 | Alternative Config 3 Active | |
| 50 | Reserved | |

8.4 SELECTION OF SENSORS

Table 13 - Sensors Selection

| No. | | Description | Remark |
|-----|--------------------------------|--|--|
| 1 | Temperature Sensor | 0 Not used 1 Custom resistor type curve 2 Custom current/voltage curve 3 VDO 4 CURTIS 5 VOLVO-EC 6 DATCON 7 SGX 8 SGD 9 SGH 10 PT100 11 SUZUKI 12-15 Reserved | Defined resistance's range is 0~6KΩ, default is SGX sensor. |
| 2 | Oil Pressure (Pressure) Sensor | 0 Not used 1 Custom resistor type curve 2 Custom current/voltage curve 3 VDO 10Bar 4 CURTIS 5 VDO 5Bar 6 DATCON 10Bar 7 SGX 8 SGD 9 SGH 10 VOLVO-EC 11 SUZUKI 12 4-20mA 10Bar 13 0-5V 10Bar 14-15 Reserved | Factory default is resistor type pressure sensor and defined resistance's range is 0~6KΩ, default is SGX sensor. |
| 3 | Liquid (Fuel) Level Sensor | 0 Not used 1 Custom resistor type curve 2 Custom current/voltage curve 3 SGD 4 SGH 5 SUZUKI 6-15 Reserved | Defined resistance's range is 0~6KΩ, default is SGH sensor. |

NOTE: pressure sensor and flexible sensor 1 connected input signals are resistor, current and voltage signals. When configuring "custom current/voltage curve" via controller panel, X coordinate data need to be expanded tenfold, for example, for 4mA, input data is "40".

8.5 CONDITIONS OF CRANK DISCONNECT SELECTION

Table 14 - Crank Disconnect Conditions Selection

| No. | Setting description |
|-----|--------------------------------------|
| 0 | Gen frequency |
| 1 | Speed |
| 2 | Speed + Gen frequency |
| 3 | Oil pressure |
| 4 | Oil pressure + Gen frequency |
| 5 | Speed + Oil pressure |
| 6 | Speed + Gen frequency + Oil pressure |

▲NOTES:

- There are 3 conditions to make starter separate with engine; speed, generator frequency and oil pressure can be used separately while it is suggested that oil pressure is used together with speed and generator frequency. The aim is to disconnect the starter motor as soon as possible.
- Speed sensor is the magnetic equipment installed in starter for detecting flywheel teeth.
- When it is setting speed, users must ensure that the number of flywheel teeth is as same as the set, otherwise, “over speed shutdown” or “under speed shutdown” may be caused.
- If genset is without speed sensor, please don't select corresponding items, otherwise, “start fail” or “loss speed signal” maybe be caused.
- If genset is without oil pressure sensor, please don't select corresponding items.
- If generator frequency is not selected in crank disconnect setting, controller will not collect and display the relative power quantity (which can be used in water pump set); if speed is not selected in crank disconnect setting, the engine speed displayed in controller is calculated by generator signal.

9 PARAMETERS SETTING

9.1 MENU ITEMS

Start the controller, then press  to enter the parameters setting menu. And menu items are as follows:

- Parameters Set
- Language
- Event Log
- Information
- Date and Time
- Cycle Start
- Bat Low Volt start

9.2 CONTROLLER PARAMETER SETTINGS

After password “0318” is inputted, all parameter items can be set. If the default password is changed, in case parameter setting is conducted on PC, users need to input the same password as the controller. If it is needed to set more parameters or password is forgotten, for example, voltage/current calibration, please contact the factory.

▲NOTES:

- a) Please change the controller parameters when generator is in standby mode (e. g. Crank disconnect conditions selection, digital inputs, relay outputs, various delays), otherwise, shutdown and other abnormal conditions may occur.
- b) Upper limit value must be higher than lower limit value, for example, over voltage limit must be higher than under voltage limit, otherwise over voltage and under voltage conditions may occur simultaneously.
- c) Over speed limit value must be higher than under speed limit value, otherwise over speed and under speed conditions may occur simultaneously.
- d) Please set return values correctly while setting warning alarms, otherwise, alarm fault may occur. Return value needs to be less than pre-set value while setting high warnings; Return value needs to be greater than pre-set value while setting low warnings;
- e) Please set the generator frequency value as low as possible when cranking, in order to make the starter be separated quickly as soon as possible.
- f) Auxiliary input 1~7 cannot be set as same items; otherwise, there are abnormal functions. However, the auxiliary output 1~6 can be set as same items.



9.3 LANGUAGE SELECTION

Chinese, English, and other languages can be optional, and other language of default is Spanish.

9.4 EVENT LOG

Max 99 pieces of historical records can be checked via this item.

9.5 CONTROLLER INFORMATION

- a) LCD will display development information of controller like software version, issue date of the controller.
- b) In this screen, press  and it shall display the digital inputs and outputs status.
- c) In this screen, press  and it shall display boot screen.

9.6 TIME SETTING

In this page, time & data information of controller can be calibrated.

9.7 CYCLE START SETTING

In this page, enable cycle start gen-sets can be set. Users can configure the main/standby set and genset running time.

9.8 BATTERY UNDER VOLTAGE START SETTING

In this page, battery under voltage start enable, start/stop values and delay values can be set.

10 GENSETS CYCLE START

Cycle start means controlling two generator-sets circulatory start/stop. Two sets are connected via CAN. Main set sends commands to control the backup set to start/stop and check fault status of backup set. The priority unit can be configured through parameter settings or input port settings. It is

only active in auto mode.

Operational Process:

- a) When remote start input is active, the main set is in standby status, it will start automatically, and the running time is the pre-configured “Main Set Running Time”;
- b) If “Main Set Running Time” is expired or alarm shutdown occurs, main set will send command to start backup set. When backup set remote start input is active, it will start up and main set will stop as soon as the standby unit is normal running. Backup running time is pre-configured “Backup Set Running Time”;
- c) In the whole process, main set communicates with backup set via CAN, if backup unit running time is expired or alarm shutdown occurs, main set will circularly start up again.
- d) If communication has error, controller will initiate “Cycle Start Comm. Fail” alarm. Then main/backup set will start if remote start input of main/backup set is active.

11 SENSOR SETTING

- When sensors are reselected, the sensor curve will be transferred into the standard value. For example, if temperature sensor is SGH (120°C resistor type) at default factory, its sensor curve is SGH (120°C resistor type); if SGD (120°C resistor type) is selected, the temperature sensor curve is SGD curve.
- If there is difference between standard sensor curves and the used sensor, users can select “defined sensor”, and then input defined sensor curve.
- When the sensor curve is inputted, X value (resistor) must be inputted from small to large, otherwise, mistake occurs.
- If sensor is selected as “Not Used”, sensor curve will not work.
- The corresponding sensor must be configured as “Not Used” if sensor only has alarm switch, otherwise, alarm shutdown or warning may occur.
- The headmost or backmost values in the vertical coordinates can be set as same as below.

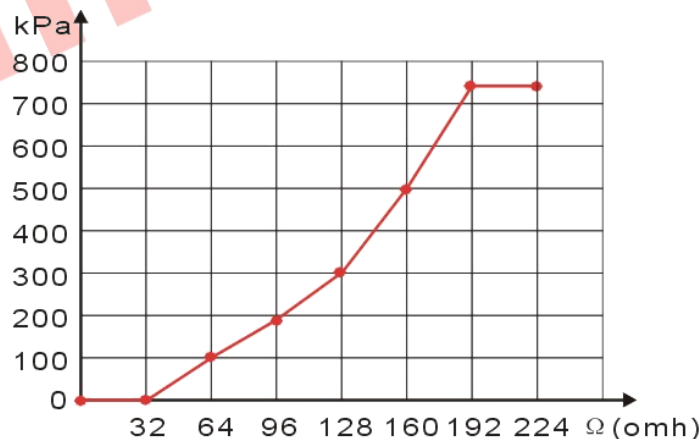

Figure 3 – Curve Setting

Table 15 - Common Unit Conversion Table

| Items | N/m ² (pa) | kgf/cm ² | bar | (p/in ² .psi) |
|----------------------|-----------------------|-----------------------|-----------------------|--------------------------|
| 1Pa | 1 | 1.02x10 ⁻⁵ | 1x10 ⁻⁵ | 1.45x10 ⁻⁴ |
| 1kgf/cm ² | 9.8x10 ⁴ | 1 | 0.98 | 14.2 |
| 1bar | 1x10 ⁵ | 1.02 | 1 | 14.5 |
| 1psi | 6.89x10 ³ | 7.03x10 ⁻² | 6.89x10 ⁻² | 1 |

12 COMMISSIONING

Please make sure the following checks are made before commissioning,

- Ensure all the wiring connections are correct and wire diameter is suitable.
- Ensure that the controller DC power has fuse, and controller’s positive and negative and start battery are correctly connected.
- Emergency stop input is connected to the positive pole of starter battery via emergency stop button’s normally closed point and fuse.
- Take proper actions to prevent engine from cranking successfully (e. g. Remove the connection wire of fuel valve). If checking is OK, make the start battery power on; choose manual mode and controller will executive routine.
- Set controller under manual mode, press “start” button, and genset will start. After the cranking times set before, controller will send signal of Start Failure; then press “stop” to reset controller.
- Recover the action to prevent engine from cranking successfully (e. g. Connect wire of fuel valve), press start button again, and genset will start. If everything goes well, genset will be normally running after idle running (if idle run is set). During this time, please watch engine’s running situation and AC generator’s voltage and frequency. If there is something abnormal, stop genset and check all wiring connections according to this manual.
- Select the **AUTO** mode from controller’s panel, and connect mains signal. After the mains normal delay, controller will transfer ATS (if set) into mains load. After cooling time, controller will stop genset and make it into “at rest” mode until there is mains abnormal situation.
- When mains is abnormal again, genset will be started automatically and enter into normal running, then controller send signal to make generator switch on, and control the ATS transfer into generator load. If it is not like this, please check ATS’ wiring connection according to this manual.
- If there is any other question, please contact SmartGen’s service.

13 TYPICAL APPLICATION

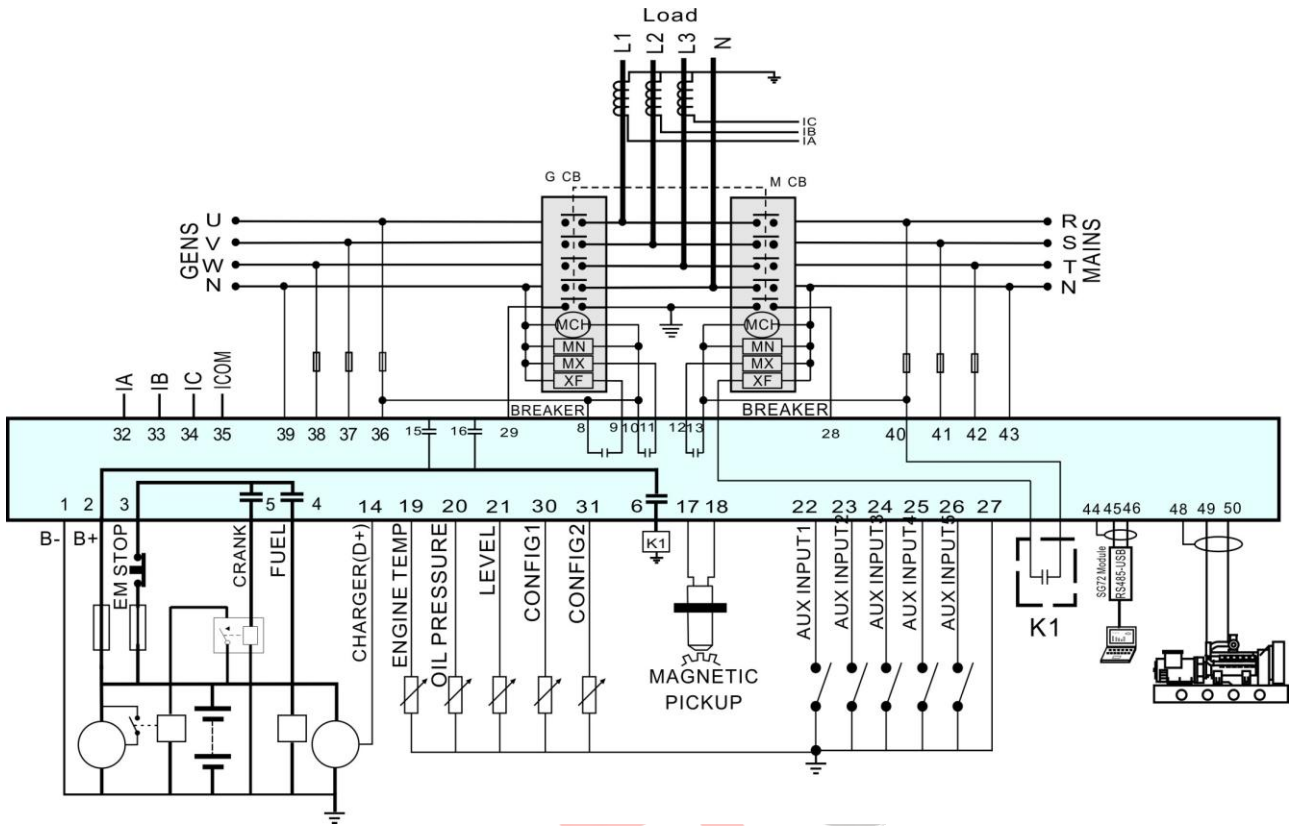

Figure 4 - HGM7220S Typical Application

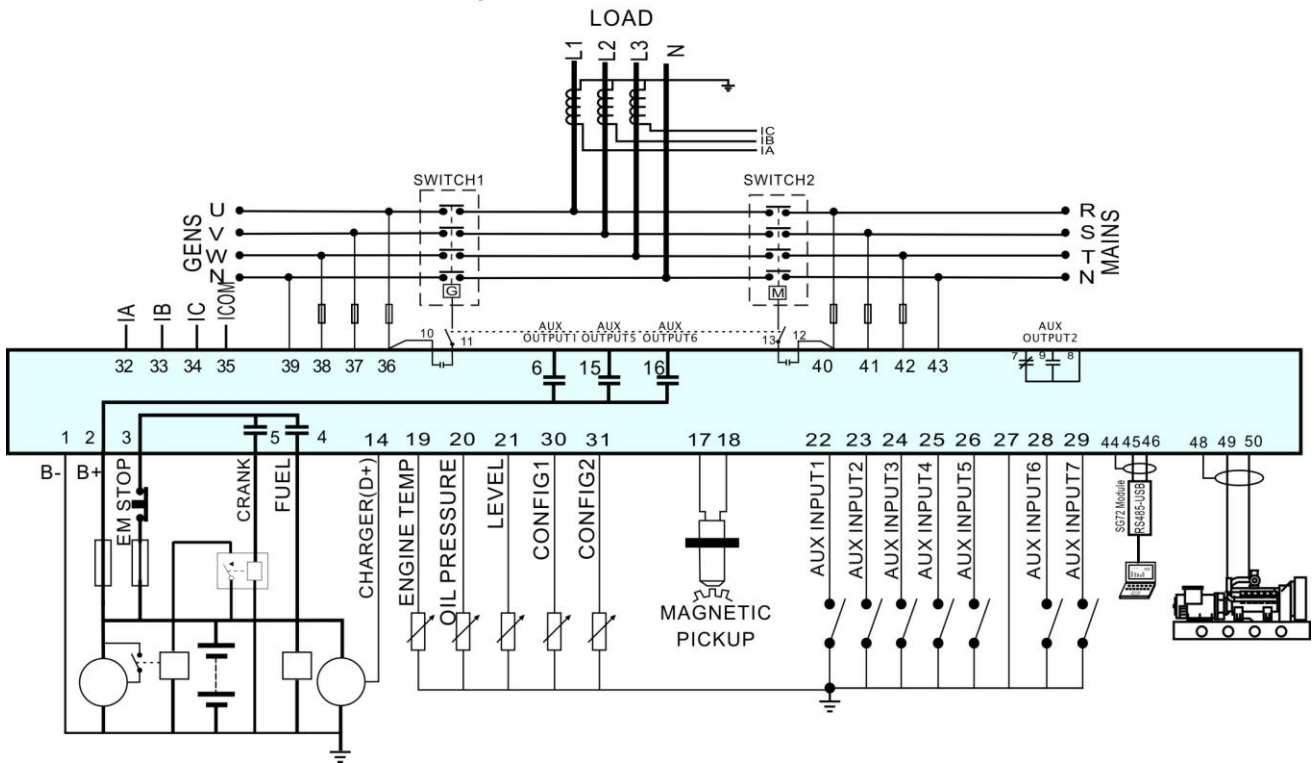

Figure 5 - HGM7220N Typical Application

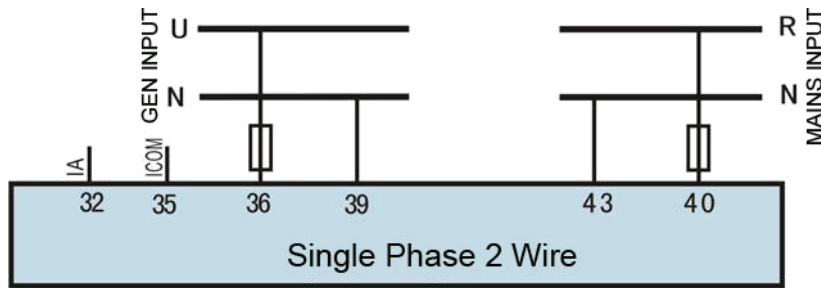

Figure 6 - Single Phase 2-Wire Connection Diagram

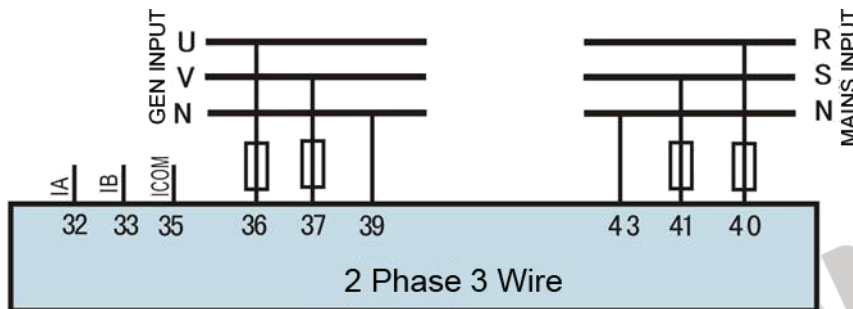

Figure 7 – 2-Phase 3-Wire Connection Diagram

▲ NOTE: Expand relay with high capacity in start and fuel output is recommend.

14 INSTALLATION

14.1 SGE02 EXPANSION MODULE

14.1.1 4G ANTENNA PORT

Connect 4G antenna and 4G port of SGE02.

Antenna port: 50Ω/SMA USB.

14.1.2 GPS ANTENNA PORT

Make GPS function enable, and connect GPS antenna and GPS port of SGE02.

▲ NOTE: GPS antenna needs to be placed at open outdoor, otherwise location information shall be incorrect, or cannot be obtained.

Antenna port: 50Ω/SMA USB. Active antenna.

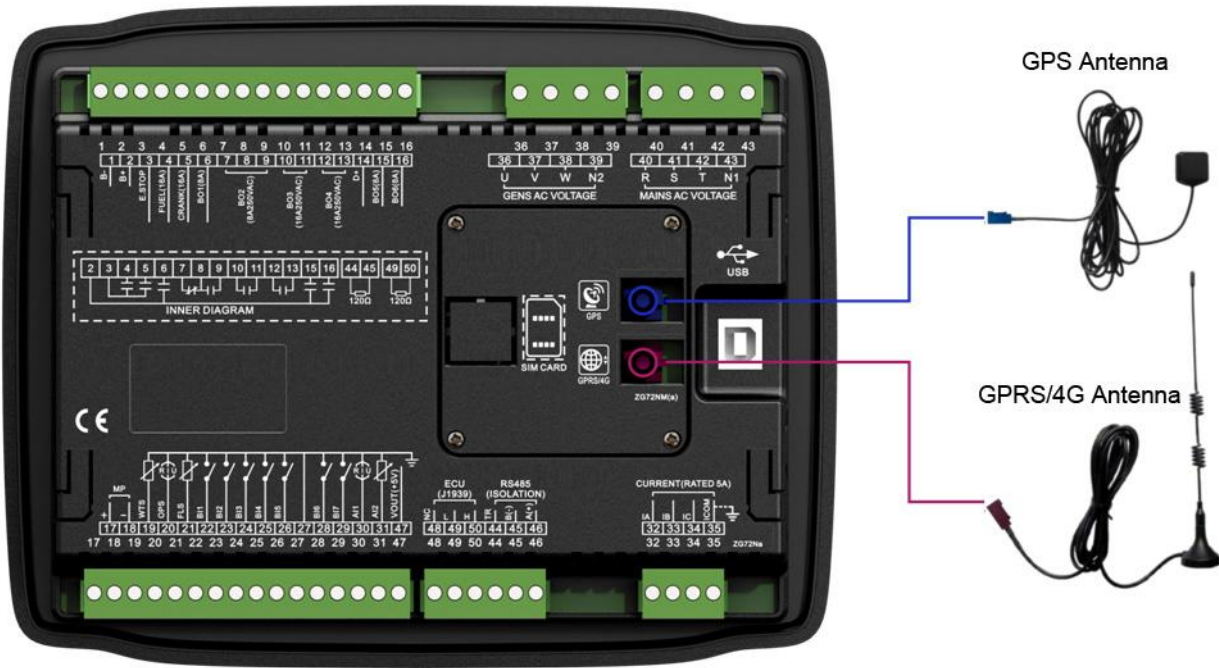



Figure 8 - HGM7220N/7220S Antenna Connection

14.1.3 SIM CARD INSTALLATION

Insert 4G, 3G or 2G SIM card, and connect it with servicer via wireless network.

▲ NOTE: This module supports 4G wireless network fitting all networks. Standard SIM card (size: 25mmx15mm) is applied. It displays  on the controller, and this means SIM is not inserted or SIM contact is not good.

Please refer to the following installation steps.

1. Unpack the cover;
2. Insert SIM card;
3. Lock SIM card;
4. Install the cover.



Figure 9 – SIM Installation Steps

14.2 FIXING CLIPS

- Controller is panel built-in design; it is fixed by clips when installed.
- Withdraw the fixing clip screw (turn anticlockwise) until it reaches proper position.
- Pull the fixing clip backwards (towards the back of the module) and ensure two clips are inside their allotted slots.
- Turn the fixing clip screws clockwise until they are fixed on the panel.
- Care should be taken not to over tighten the screws of fixing clips.

14.3 OVERALL DIMENSION

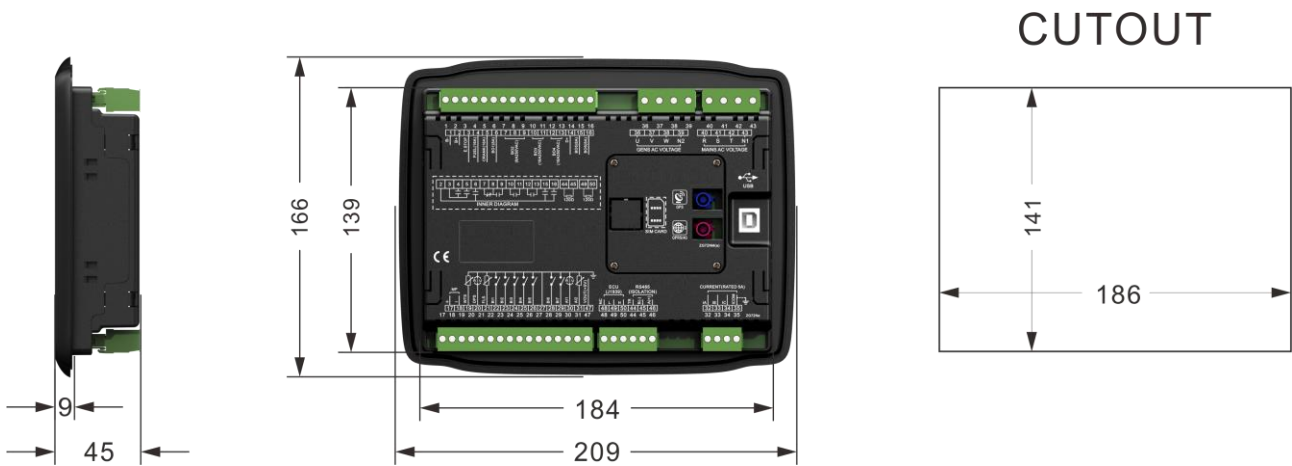

Figure 10 - Overall Dimensions

HGM7220N/7220S series controller can suit for wide range of battery voltage DC (8~35) V. Negative of battery must be connected with the engine shell. Diameter of wire that connects power supply with battery must be over 2.5mm². If floating charger is configured, please firstly connect output wires of charger to battery's positive and negative directly, then, connect wires from battery's positive and negative to controller's positive and negative input ports in order to prevent charger disturbing the controller's normal working.

— **SPEED SENSOR INPUT:** Speed sensor is the magnetic equipment installed in starter and for detecting flywheel teeth. Its connection wires with the controller should apply 2-core shielding line. The shielding layer should connect to No. 18 terminal in controller while another side is hanging in air. The else two signal wires are connected to No.17 and No.18 terminals in controller. The output voltage of speed sensor should be within (1~24) VAC (effective value) during the full speed. 12VAC is recommended (in rated speed). When the speed sensor is installed, let the sensor spun to contacting flywheel first, then, make it back 1/3 lap, and lock the nuts of sensor at last.

— **OUTPUT AND EXPAND RELAYS:** All outputs of controller are relay contact output type. If expansion relays are needed, please add freewheel diode to both ends of expansion relay's coils (when coils of relay has DC current) or, increase resistance-capacitance return circuit (when coils of relay has AC current), in order to prevent disturbance to controller or other equipments.

— **AC INPUT:** Current input of HGM7220N/7220S series controller must be connected to outside current transformer. And the current transformer's secondary side current must be 5A. At the same time, the phases of current transformer and input voltage must be correct. Otherwise, the current collected and active power maybe not be correct.

— **WITHSTAND VOLTAGE TEST:** When controller had been installed on display window, if the high voltage test is needed, please disconnect controller's all terminal connections, in order to prevent high voltage getting into controller and damaging it.

▲NOTES:

- a) ICOM port must be connected to negative pole of battery.
- b) When there is load current, open circuit is prohibited on transformer's secondary side.

15 SMS MESSAGE ALARM AND REMOTE CONTROL

16.1 SMS MESSAGE ALARM

When controller detects alarms, it shall sends messages automatically to the set mobile number.

NOTE: All stop alarms, trip and stop alarms, trip alarms will send messages to the pre-set phone number and optional alarms will send messages to the phone according to user settings.

16.2 SMS MESSAGE REMOTE CONTROL

Users sends messages to the wireless communication module, and controller shall act the actions according to the message orders and return the action information. Controller only acts the orders from phone messages that set by itself. For details please see the following table.

Table 16 - SMS Message Order List

| No. | Message Order | Message Return Information | Description |
|-----|-----------------|---|-----------------------------------|
| 1 | SMS GENSET | GENSET ALARM | Stop alarm or trip and stop alarm |
| | | SYSTEM IN STOP MODE GENSET AT REST | Stop mode; standby status |
| | | SYSTEM IN MANUAL MODE GENSET AT REST | Manual mode; standby status |
| | | SYSTEM IN AUTO MODE GENSET AT REST | Auto mode; standby status |
| | | SYSTEM IN STOP MODE GENSET IS RUNNING | Stop mode; start status |
| | | SYSTEM IN MANUAL MODE GENSET IS RUNNING | Manual mode; start status |
| | | SYSTEM IN AUTO MODE GENSET IS RUNNING | Auto mode; start status |
| 2 | SMS START | GENSET ALARM | Stop alarm or trip and stop alarm |
| | | STOP MODE NOT START | Don't start in stop mode. |
| | | SMS START OK | Start the genset in manual mode. |
| | | AUTO MODE NOT START | Don't start in auto mode. |
| 3 | SMS STOP MODE | SMS STOP OK | Set to stop mode. |
| 4 | SMS MANUAL MODE | SMS MANUAL MODE OK | Set to manual mode. |
| 5 | SMS AUTO MODE | SMS AUTO MODE OK | Set to auto mode. |
| 6 | SMS DETAIL | Return information can be set on PC software. | Obtaining genset details. |

NOTE: Message orders shall be sent based on the contents in the table, and all letters shall be capitalized.

NOTE: Detailed contents for SMS DETAIL return include: operating mode, mains voltage, gens voltage, load current, mains frequency, gens frequency, active power, apparent power, power factor, battery voltage, D+ voltage, water temperature, oil pressure, fuel level, speed, accumulated running time, genset status, alarm status.

16 CONNECTIONS OF CONTROLLER AND J1939 ENGINE

16.1 CUMMINS ISB/ISBE

Table 17 Connector B

| Terminals of controller | Connector B | Remark |
|-------------------------|--|---------------------------------------|
| Aux. output port 1 | 39 | Set it as “fuel output”; |
| Start relay output | - | Connected with starter coil directly; |
| Auxiliary output port 2 | Expansion 30A relay; providing battery voltage for terminal 01,07,12,13; | Set it as “ECU power”; |

Table 18 9-Pin Connector

| Terminals of controller | 9 pins connector | Remark |
|-------------------------|------------------|---|
| CAN_SCR | SAE J1939 shield | CAN communication shielding line(connected with ECU terminal only); |
| CAN(H) | SAE J1939 signal | Impedance 120Ω connecting line is recommended. |
| CAN(L) | SAE J1939 return | Impedance 120Ω connecting line is recommended. |

Engine type: Cummins ISB.

16.2 CUMMINS QSL9

Suitable for CM850 engine control module.

Table 19 50-Pin Connector

| Terminals of controller | 50 pins connector | Remark |
|-------------------------|-------------------|-------------------------------------|
| Aux. output port 1 | 39 | Set it as “fuel output”; |
| Start relay output | - | Connected to starter coil directly; |

Table 20 9-Pin Connector

| Terminals of controller | 9 pins connector | Remark |
|-------------------------|--------------------|---|
| CAN_SCR | SAE J1939 shield-E | CAN communication shielding line(connected with ECU terminal only); |
| CAN(H) | SAE J1939 signal-C | Using impedance 120Ω connecting line; |
| CAN(L) | SAE J1939 return-D | Using impedance 120Ω connecting line; |

Engine type: Cummins-CM850.

16.3 CUMMINS QSM11 (IMPORT)

It is suitable for CM570 engine control module. Engine type is QSM11 G1, QSM11 G2.

Table 21 C1 Connector

| Terminals of controller | C1 connector | Remark |
|-------------------------|--------------|---|
| Aux. output port 1 | 5&8 | Set it as "fuel output"; External expansion relay; on fuel output, make port 5 and port 8 of C1 connector be connected; |
| Start relay output | - | Connected to starter coil directly; |

Table 22 3-Pin Data Link Connector

| Terminals of controller | 3 pins data link connector | Remark |
|-------------------------|----------------------------|---|
| CAN_SCR | C | CAN communication shielding line(connected with ECU terminal only); |
| CAN(H) | A | Using impedance 120Ω connecting line; |
| CAN(L) | B | Using impedance 120Ω connecting line; |

Engine type: Cummins ISB.

16.4 CUMMINS QSX15-CM570

It is suitable for CM570 engine control module. Engine type is QSX15 etc.

Table 23 50-Pin Connector

| Terminals of controller | 50 pins connector | Remark |
|-------------------------|-------------------|--|
| Aux. output port 1 | 38 | Injection switch; Set it as "fuel output"; |
| Start relay output | - | Connected to starter coil directly; |

Table 24 9-Pin Connector

| Terminals of controller | 9 pins connector | Remark |
|-------------------------|--------------------|---|
| CAN SCR | SAE J1939 shield-E | CAN communication shielding line(connected with ECU terminal only); |
| CAN(H) | SAE J1939 signal-C | Using impedance 120Ω connecting line; |
| CAN(L) | SAE J1939 return-D | Using impedance 120Ω connecting line; |

Engine type: Cummins QSX15-CM570.

16.5 CUMMINS GCS-MODBUS

It is suitable for GCS engine control module. Use RS485-MODBUS to read information of engine. Engine types are QSX15, QST30, QSK23/45/60/78 and so on.

Table 25 D-SUB Connector 06

| Terminals of controller | D-SUB connector 06 | Remark |
|-------------------------|--------------------|---|
| Aux. output port 1 | 5&8 | Set it as "fuel output"; Outside expansion relay; on fuel output, make port 05 and 08 of connector 06 be connected. |
| Start relay output | - | Connected to starter coil directly; |

Table 26 D-SUB Connector 06

| Terminals of controller | D-SUB connector 06 | Remark |
|-------------------------|--------------------|---|
| RS485 GND | 20 | CAN communication shielding line(connected with ECU terminal only); |
| RS485+ | 21 | Using impedance 120Ω connecting line; |
| RS485- | 18 | Using impedance 120Ω connecting line; |

Engine type: Cummins QSK-MOVBUS, Cummins QST-MOVBUS, Cummins QSX-MOVBUS.

16.6 CUMMINS QSM11

Table 27 Engine OEM Connector

| Terminals of controller | OEM connector of engine | Remark |
|-------------------------|-------------------------|---------------------------------------|
| Aux. output port 1 | 38 | Set it as "fuel output"; |
| Start relay output | - | Connected with starter coil directly; |
| CAN_SCR | - | CAN communication shielding line; |
| CAN(H) | 46 | Using impedance 120Ω connecting line; |
| CAN(L) | 37 | Using impedance 120Ω connecting line; |

Engine type: Common J1939.

16.7 CUMMINS QSZ13

Table 28 Engine OEM Connector

| Terminals of controller | OEM connector of engine | Remark |
|-------------------------|-------------------------|--|
| Aux. output port 1 | 45 | |
| Start relay output | - | Connected to starter coil directly; |
| Aux. output 2 | 16&41 | Set as idling speed control; (N/C) output; by expansion relay, make 16&41 close as the controller is running. |
| Aux. output 3 | 19&41 | Set as pulse speed raising control; (N/O) output; by expansion relay, make 19&41 close for 1s as the controller is entering warming-up time. |
| CAN_SCR | - | CAN communication shielding line; |
| CAN(H) | 1 | Using impedance 120Ω connecting line; |
| CAN(L) | 21 | Using impedance 120Ω connecting line; |

Engine type: Common J1939.

16.8 DETROIT DIESEL DDEC III/IV

Table 29 Engine CAN Port

| Terminals of controller | CAN port of engine | Remark |
|-------------------------|---|---------------------------------------|
| Aux. output port 1 | Expansion 30A relay, proving battery voltage for ECU; | Set it as "fuel output"; |
| Start relay output | - | Connected to starter coil directly; |
| CAN_SCR | - | CAN communication shielding line; |
| CAN(H) | CAN(H) | Using impedance 120Ω connecting line; |
| CAN(L) | CAN(L) | Using impedance 120Ω connecting line; |

Engine type: Common J1939.

16.9 DEUTZ EMR2

Table 30 F Connector

| Terminals of controller | F connector | Remark |
|-------------------------|---|--|
| Aux. output port 1 | Expansion 30A relay, proving battery voltage for 14; Fuse is 16A. | Set it as "fuel output"; |
| Start relay output | - | Connected to starter coil directly; |
| - | 1 | Connected to battery negative; |
| CAN_SCR | - | CAN communication shielding line; |
| CAN(H) | 12 | Impedance 120Ω connecting line is recommended. |
| CAN(L) | 13 | Impedance 120Ω connecting line is recommended. |

Engine type: Volvo EDC4.

16.10 JOHN DEERE

Table 31 21-Pin Connector

| Terminals of controller | 21 pins connector | Remark |
|-------------------------|-------------------|---------------------------------------|
| Aux. output port 1 | G, J | Set it as "fuel output"; |
| Start relay output | D | |
| CAN_SCR | - | CAN communication shielding line; |
| CAN(H) | V | Using impedance 120Ω connecting line; |
| CAN(L) | U | Using impedance 120Ω connecting line; |

Engine type: John Deere.

16.11 MTU MDEC

Suitable for 2000 series and 4000 series with MTU engine type.

Table 32 X1 Connector

| Terminals of controller | X1 Connector | Remark |
|-------------------------|--------------|---|
| Aux. output port 1 | BE1 | Set it as "fuel output"; |
| Start relay output | BE9 | |
| CAN_SCR | E | CAN communication shielding line(connected with one terminal only); |
| CAN(H) | G | Using impedance 120Ω connecting line; |
| CAN(L) | F | Using impedance 120Ω connecting line; |

Engine type: MTU-MDEC-303.

16.12 MTU ADEC(MODULE MODULE)

It is suitable for MTU engine with ADEC (ECU8) and SMART module.

Table 33 ADEC (X1 Port)

| Terminals of controller | ADEC (X1port) | Remark |
|-------------------------|---------------|---|
| Aux. output port 1 | X1 10 | Set it as "fuel output"; X1 9 shall connect negative of battery. |
| Start relay output | X1 34 | X1 33 shall connect negative of battery. |

Table 34 SMART (X4 Port)

| Terminals of controller | SMART (X4 port) | Remark |
|-------------------------|-----------------|---------------------------------------|
| CAN_SCR | X4 3 | CAN communication shielding line; |
| CAN(H) | X4 1 | Using impedance 120Ω connecting line; |
| CAN(L) | X4 2 | Using impedance 120Ω connecting line; |

Engine type: MTU-ADEC.

16.13 MTU ADEC (SAM MODULE)

It is suitable for MTU engine with ADEC (ECU8) and SMART module.

Table 35 ADEC (X1 Port)

| Terminals of controller | ADEC (X1port) | Remark |
|-------------------------|---------------|--|
| Aux. output port 1 | X1 43 | Set it as "fuel output"; X1 28 shall connect negative of battery. |
| Start relay output | X1 37 | X1 22 shall connect negative of battery. |

Table 36 SAM (X23 Port)

| Terminals of controller | SAM (X4 port) | Remark |
|-------------------------|---------------|---------------------------------------|
| CAN_SCR | X23 3 | CAN communication shielding line; |
| CAN(H) | X23 2 | Using impedance 120Ω connecting line; |
| CAN(L) | X23 1 | Using impedance 120Ω connecting line; |

Engine type: Common J1939.

16.14 PERKINS

It is suitable for ADEM3/ ADEM4 engine control module. Engine type is 2306, 2506, 1106, and 2806.

Table 37 Connector

| Terminals of controller | Connector | Remark |
|-------------------------|---------------|---------------------------------------|
| Aux. output port 1 | 1,10,15,33,34 | Set it as "fuel output"; |
| Start relay output | - | Connected to starter coil directly; |
| CAN_SCR | - | CAN communication shielding line; |
| CAN(H) | 31 | Using impedance 120Ω connecting line; |
| CAN(L) | 32 | Using impedance 120Ω connecting line; |

Engine type: Perkins.

16.15 SCANIA

It is suitable for S6 engine control module. Engine type is DC9, DC12, and DC16.

Table 38 B1 Connector

| Terminals of controller | B1 connector | Remark |
|-------------------------|--------------|---------------------------------------|
| Aux. output port 1 | 3 | Set it as "fuel output"; |
| Start relay output | - | Connected to starter coil directly; |
| CAN_SCR | - | CAN communication shielding line; |
| CAN(H) | 9 | Using impedance 120Ω connecting line; |
| CAN(L) | 10 | Using impedance 120Ω connecting line; |

Engine type: Scania.

16.16 VOLVO EDC3

Suitable engine control mode is TAD1240, TAD1241, and TAD1242.

Table 39 "Stand Alone" Connector

| Terminals of controller | "Stand alone" connector | Remark |
|-------------------------|-------------------------|------------------------------|
| Aux. output port 1 | H | Set it as "fuel output"; |
| Start relay output | E | |
| Aux. output 2 | P | Set output 2 as "ECU power"; |

Table 40 "Data Bus" Connector

| Terminals of controller | "Data bus" connector | Remark |
|-------------------------|----------------------|---------------------------------------|
| CAN_SCR | - | CAN communication shielding line; |
| CAN(H) | 1 | Using impedance 120Ω connecting line; |
| CAN(L) | 2 | Using impedance 120Ω connecting line; |

Engine type: Volvo.

NOTE: When this engine type is selected, preheating time should be set to at least 3 seconds.

16.17 VOLVO EDC4

Suitable engine types are TD520, TAD520 (optional), TD720, TAD720 (optional), TAD721, TAD722, and TAD732.

Table 41 Connector

| Terminals of controller | Connector | Remark |
|-------------------------|--|---------------------------------------|
| Aux. output port 1 | Expansion 30A relay, providing battery voltage for terminal 14. Fuse is 16A. | Set it as “fuel output”; |
| Start relay output | - | Connected to starter coil directly; |
| | 1 | Connected to negative of battery; |
| CAN_SCR | - | CAN communication shielding line; |
| CAN(H) | 12 | Using impedance 120Ω connecting line; |
| CAN(L) | 13 | Using impedance 120Ω connecting line; |

Engine type: Volvo EDC4.

16.18 VOLVO-EMS2

Volvo Engine types are TAD734, TAD940, TAD941, TAD1640, TAD1641, and TAD1642.

Table 42 Engine CAN Port

| Terminals of controller | Engine's CAN port | Remark |
|-------------------------|-------------------|---------------------------------------|
| Aux. output 1 | 6 | Set output 1 “ECU stop”; |
| Aux. output 2 | 5 | Set output 2 “ECU power”; |
| | 3 | Power negative; |
| | 4 | Power passive; |
| CAN_SCR | - | CAN communication shielding line; |
| CAN(H) | 1(Hi) | Using impedance 120Ω connecting line; |
| CAN(L) | 2(Lo) | Using impedance 120Ω connecting line; |

Engine type: Volvo-EMS2.

NOTE: When this engine type is selected, preheating time should be set to at least 3 seconds.

16.19 YUCHAI

It is suitable for BOSCH common rail pump engine.

Table 43 Engine 42-Pin Port

| Terminals of controller | Engine 42 pins port | Remark |
|-------------------------|---------------------|--|
| Aux. output port 1 | 1.40 | Set it as “fuel output”; Connected to engine ignition lock; |
| Start relay output | - | Connected to starter coil directly; |
| CAN_SCR | - | CAN communication shielding line; |
| CAN(H) | 1.35 | Using impedance 120Ω connecting line; |
| CAN(L) | 1.34 | Using impedance 120Ω connecting line; |

Table 44 Engine 2-Pin Port

| Battery | Engine 2 pins | Remark |
|------------------|---------------|------------------------------------|
| Battery negative | 1 | Wire diameter 2.5mm ² ; |
| Battery positive | 2 | Wire diameter 2.5mm ² ; |

Engine type: BOSCH.

16.20 WEICHAİ

It is suitable for Weichai BOSCH common rail pump engine.

Table 45 Engine Port

| Terminals of controller | Engine port | Remark |
|-------------------------|-------------|--|
| Aux. output port 1 | 1.40 | Set it as "fuel output"; Connected to engine ignition lock; |
| Start relay output | 1.61 | |
| CAN_SCR | - | CAN communication shielding line; |
| CAN(H) | 1.35 | Using impedance 120Ω connecting line; |
| CAN(L) | 1.34 | Using impedance 120Ω connecting line; |

Engine type: GTSC1.

▲NOTE: If there is any question of connection between controller and ECU communication, please feel free to contact SmartGen's service.

SmartGen

17 TROUBLESHOOTING
Table 46 - Troubleshooting

| Symptoms | Possible Solutions |
|---|---|
| Controller no response with power. | Check starting batteries; Check controller connection wirings; Check DC fuse. |
| Gen-set shutdown | Check the water/cylinder temperature is too high or not; Check the gen-set AC voltage; Check DC fuse. |
| Controller emergency stop | Check the function of emergency stop is correct or not; Check whether the positive electrode of battery is connected with emergency stop input correctly or not; Check whether wire connection is open circuit or not. |
| Low oil pressure alarm after crank disconnect | Check the oil pressure sensor and its connections. |
| High water temp. alarm after crank disconnect | Check the temperature sensor and its connections. |
| Shutdown Alarm in running | Check related switch and its connections according to the information on LCD; Check programmable inputs. |
| Crank not disconnection | Check fuel oil circuit and its connections; Check starting batteries; Check speed sensor and its connections; Refer to engine manual. |
| Starter no response | Check starter connections; Check starting batteries. |
| Gen-set running while ATS not transfer | Check ATS; Check the connections between ATS and controllers. |
| RS485 communication is abnormal | Check connections; Check setting of COM port is correct or not; Check RS485's A and B connection is reversely connected or not; Check communication port of PC is damaged or not. Adding 120 Ω resistor between A and B of RS485 is recommended. |

18 Appendix

Table 47 SGE02-4G Order Model

| Model | Country | Frequency Channel | Remark |
|--------------|--|---|-------------|
| SGE02-4G | Chinese Mainland | FDD-LTE: B1/B3/B8 TDD-LTE: B38/B39/B40/B41 TD-SCDMA: B34/B39 WCDMA: B1/B8 EVDO/CDMA: BC0 GSM: 900/1800MHz | SIM7600CE |
| SGE02-4G-S01 | North America | FDD-LTE: B2/B4/B12 WCDMA: B2/B5 | SIM7600A-H |
| SGE02-4G-S02 | | FDD-LTE: B2/B4/B5/B13 | SIM7600V-H |
| SGE02-4G-S03 | Europe/Africa/Korea/ Thailand/Middle East | FDD-LTE: B1/B3/B5/B7/B8/B20 TDD-LTE: B38/B40/B41 WCDMA: B1/B5/B8 GSM: 900/1800MHz | SIM7600E-H |
| SGE02-4G-S04 | South America /Australia/NewZealand | FDD-LTE: B1/B2/B3/B4/B5/B7/B8/B28 TDD-LTE: B40 WCDMA: B1/B2/B5/B8 GSM: 850/900/1800/1900MHz | SIM7600SA-H |
| SGE02-4G-S05 | Japan | FDD-LTE: B1/B3/B8/B18/B19/B26 | SIM7600JC-H |