



SmartGen
ideas for power

HGM8151

Genset Parallel (With Genset) Unit

USER MANUAL



SMARTGEN (ZHENGZHOU) TECHNOLOGY CO.,LTD.

CONTENTS

1	OVERVIEW	6
2	PERFORMANCE AND CHARACTERISTICS	7
3	SPECIFICATION.....	9
4	OPERATION	10
4.1	INDICATORS.....	10
4.2	PUSHBUTTONS.....	10
4.3	LCD DISPLAY.....	11
4.3.1	MAIN DISPLAY	11
4.3.2	PARAMETERS SETTING MANUAL	13
4.3.3	PARAMETER SETTING	13
4.4	AUTO START/STOP OPERATION.....	14
4.5	MANUAL START/STOP OPERATION.....	15
4.6	SWITCH CONTROL PROCEDURES.....	15
4.6.1	MANUAL TRANSFER PROCEDURES	15
4.6.2	AUTOMATIC CONTROL PROCEDURE	15
5	PROTECTIONS	16
5.1	WARNING ALARMS.....	16
5.2	SHUTDOWN ALARMS.....	18
5.3	TRIP AND STOP ALARMS.....	20
5.4	TRIP ALARM	21
6	WIRING CONNECTION	22
7	SCOPES AND DEFINITIONS OF PROGRAMMABLE PARAMETERS	25
7.1	CONTENTS AND SCOPES OF PARAMETERS.....	25
7.2	ENABLE DEFINITION OF PROGRAMMABLE OUTPUT PORTS	34
7.2.1	DEFINED PERIOD OUTPUT	38
7.2.2	DEFINED COMBINATION OUTPUT	38
7.3	DEFINED CONTENTS OF PROGRAMMABLE INPUT PORTS	39
7.4	SELECTION OF SENSORS.....	41
7.5	CONDITIONS OF CRANK DINSCONNECT SELECTION.....	42
8	PARAMETERS SETTING.....	43
9	SENSORS SETTING.....	43
10	COMMISSIONING	44
10.1	STEP 1: SINGLE UNIT DEBUGGING	44
10.2	STEP 2: MANUAL PARALLEL OPERATION OFF-LOAD	44
10.3	STEP 3: MANUAL PARALLEL OPERATION ON-LOAD.....	44
10.4	STEP 4: AUTOMATIC PARALLEL OPERATION.....	45
11	TYPICAL APPLICATION	46
12	POWER MANAGEMENT MODE.....	48
13	NEL TRIP ILLUSTRATION.....	49
14	INSTALLATION.....	50
14.1	BATTERY VOLTAGE INPUT.....	50
14.2	SPEED SENSOR INPUT.....	50

14.3	OUTPUT AND EXPAND RELAYS.....	50
14.4	AC INPUT	50
14.5	WITHSTAND VOLTAGE TEST	50
15	GSM SHORT MESSAGE ALARM AND REMOTE CONTROL.....	51
15.1	GSM SHORT MESSAGE ALARM.....	51
15.2	GSM SHORT MESSAGE REMOTE CONTROL	51
16	CONNECTIONS OF CONTROLLER WITH J1939 ENGINE	53
16.1	CUMMINS ISB/ISBE.....	53
16.2	CUMMINS QSL9.....	53
16.3	CUMMINS QSM11(IMPORT).....	53
16.4	CUMMINS QSX15-CM570	54
16.5	CUMMINS GCS-MODBUS.....	54
16.6	CUMMINS QSM11.....	54
16.7	CUMMINS QSZ13	55
16.8	DETROIT DIESEL DDEC III / IV	55
16.9	DEUTZ EMR2.....	55
16.10	JOHN DEERE.....	56
16.11	MTU MDEC.....	56
16.12	MTU ADEC(SMART MODULE).....	56
16.13	MTU ADEC(SAM MODULE).....	56
16.14	PERKINS.....	57
16.15	SCANIA.....	57
16.16	VOLVO EDC3.....	57
16.17	VOLVO EDC4.....	58
16.18	VOLVO-EMS2.....	58
16.19	YUCHAI.....	58
16.20	WEICHAI.....	59
17	ETHERNET INTERFACE	60
17.1	ETHERNET INTERFACE INTRODUCTION	60
17.2	NETWORK CLIENT MODE	60
17.3	CONTROLLER AND NETWORK CABLE CONNECTION	60
17.3.1	CONTROLLER CONNECT WITH PC WITH A LINE OF CABLE	60
17.3.2	CONTROLLER AND PC CONNECTION VIA SWITCHBOARD (OR ROUTER).....	60
18	FAULT FINDING.....	61



Chinese trademark

SmartGen English trademark

SmartGen —make your generator *smart*

SmartGen Technology Co., Ltd

No. 28 Jinsuo Road

Zhengzhou City

P. R. China

Tel: +86-371-67988888

+86-371-67981888

+86-371-67991553

+86-371-67992951

+86-371-67981000 (overseas)

Fax: 0086-371-67992952

Web: <http://www.smartgen.com.cn>

<http://www.smartgen.cn>

Email: sales@smartgen.cn

All rights reserved. No part of this publication may be reproduced in any material form (including photocopying or storing in any medium by electronic means or other) without the written permission of the copyright holder.



SmartGen Technology reserves the right to change the contents of this document without prior notice.

Software Version

Date	Version	Content
2016-07-24	1.0	Original release

This user manual only suits for HGM8151 controller.

Notation Clarification as follows,

Symbol	Instruction
 NOTE	Highlights an essential element of a procedure to ensure correctness.
 CAUTION	Indicates a procedure or practice, which, if not strictly observed, could result in damage or destruction of equipment.
 WARNING	Indicates a procedure or practice, which could result in injury to personnel or loss of life if not followed correctly.

SmartGen

1 OVERVIEW

HGM8151 genset parallel controller is especially designed for extremely high/low temperature environment (-40~+70) °C. The controllers can operate reliability in extreme temperature conditions with the help of VFD display or LCD and the components that resist extreme temperature. Controller has strong ability of anti-electromagnetic interference, can be used under complex electromagnetic interference environment. It is easy to maintain and upgrade due to the plug-in terminal. All display information is Chinese (also can be set as English or other languages)

HGM8151 controller is designed for manual/auto parallel system generators with similar or different capacity. Additionally, it is suitable for single unit constant power output and mains paralleling. It allows automatic start/stop, parallel running, data measurement, alarm protection as well as remote control, remote measurement and remote communication function. Utilizing the GOV (Engine Speed Governor) and AVR (Automatic Voltage Regulator) control function, the controller is able to synchronize and share load automatically; it can be used to parallel with other HGM8151 controller.

HGM8151 controller also monitors the engine, indicating the operational status and fault conditions accurately. When abnormal condition occurs, it splits bus and shuts down the genset, simultaneously the exact failure mode information is indicated by the LCD display on the front panel. SAE J1939 interface enables the controller to communicate with various ECU (ENGINE CONTROL UNIT) which fitted with J1939 interface.

The powerful 32-bit Microprocessor contained within the module allows for precision parameters measuring, fixed value adjustment, time setting and set value adjusting and etc..Majority parameters can be configured from front panel, and all parameters can be configured by USB interface to adjust and by RS485 or ETHERNET to adjust and monitor via PC. It can be widely used in all types of automatic gen-set control system with compact structure, advanced circuits, simple connections and high reliability.

2 PERFORMANCE AND CHARACTERISTICS

- With ARM-based 32-bit SCM, high integration of hardware and more reliable.
- Graphics dot-matrix VFD with large screen, multilingual interface (including English, Chinese or other languages) which can be chosen at the site, making commissioning convenient for factory personnel.
- Improved LCD wear-resistance and scratch resistance due to hard screen acrylic.
- Silicon panel and pushbuttons for better operation in high/low temperature environment.
- RS485 communication port enables remote control, remote measuring, and remote communication via ModBus protocol.
- ETHERNET communication port enables ETHERNET monitoring. (controller must be with ETHERNET port)
- Equipped with SMS (Short Message Service) function. When genset is alarming, controller can send short messages via SMS automatically to max. 5 telephone numbers. Besides, generator status can be controlled and checked using SMS.
- Fitted with CANBUS port and can communicate with J1939 genset. Not only can monitor frequently-used data (such as water temperature, oil pressure, engine speed, fuel consumption and so on) of genset, but also control start, stop, raising speed and speed droop via CAN BUS port. (need controller with CAN BUS port)
- Suitable for 3-phase 4-wire, 3-phase 3-wire, single phase 2-wire, and 2-phase 3-wire systems with voltage 120/240V and frequency 50/60Hz.
- Collects and shows 3-phase voltage, current, power parameter and frequency of Bus/mains.
- For Bus, controller has loss of phase and phase sequence wrong detection functions; For generator, controller has over voltage, under voltage, over frequency, under frequency, over current, over power, reverse power, loss of phase, phase sequence wrong detection functions.
- 3 fixed analog sensors (temperature, oil pressure and liquid level).
- 2 configurable sensors can be set as sensor of temperature, oil pressure or fuel level.
- Precision measure and display parameters about Engine,

Temp. (WT)	°C/°F both be displayed
Oil pressure (OP)	kPa/psi/bar all be displayed
Fuel level (FL)	%(unit)
Speed (SPD)	r/min(unit)
Battery Voltage (VB)	V (unit)
Charger Voltage (VD)	V (unit)
- Hour count (HC) can accumulate Max. 65535 hours.
- Start times can accumulate Max. 65535 times
- Protection: automatic start/stop of the gen-set, ATS(Auto Transfer Switch) control with perfect fault indication and protection function.

- All output ports are relay output.
- Parameter setting: parameters can be modified and stored in internal FLASH memory and cannot be lost even in case of power outage; most of them can be adjusted using front panel of the controller and all of them can be modified using PC via USB, RS485 or ETHERNET ports.
- Sensor curves are user-defined and multiple sensor curves (temperature, pressure and oil pressure) can be used directly.
- Multiple crank disconnect conditions (rotate speed, oil pressure, generator frequency) are optional.
- Widely power supply range DC(8~35)V, suitable to different starting battery voltage environment.
- Event log, real-time clock, scheduled start & stop generator (can be set as start genset once a day/week/month whether with load or not).
- Can be used as indicator (only indicate and alarm, relay without action).
- With maintenance function. Actions (warning, trip and stop, shutdown) can be set when maintenance time out.
- All parameters used digital adjustment, instead of conventional analog modulation with normal potentiometer, more reliability and stability.
- IP55 waterproofness level can be achieved with the help of rubber-ring gasket between shell and control panel.
- Metal fixing clips enable perfect in high temperature environment.
- Modular design, self-extinguishing ABS plastic shell, pluggable terminal, built-in mounting , compact structure with easy installation.
- Accumulative total run time and total electric energy of A and B. Users can reset it as 0 and re-accumulative the value which make convenience to users to count the total value as their wish.

3 SPECIFICATION

Parameter	Details
Working Voltage	DC8. 0V to 35. 0V, uninterruptible power supply
Overall Consumption	<4W (Standby mode: ≤2W)
AC Input:	
3 Phase 4 Wire	AC 15V - 360V (ph-N)
3 Phase 3 Wire	AC 30V - 620V (ph- ph)
Single Phase 2 Wire	AC 15V - 360V (ph-N)
2 Phase 3 Wire	AC 15V - 360V (ph-N)
Alternator Frequency	50Hz/60Hz
Speed Sensor Voltage	1. 0 V to 24 V (RMS)
Speed Sensor Frequency	Maximum 10,000 Hz
Start Relay Output	16A DC28V power supply output
Fuel Relay Output	16A DC28V power supply output
Flexible Relay Output 1	7A DC28V power supply output
Flexible Relay Output 2	7A DC28V power supply output
Flexible Relay Output 3	7A DC28V power supply output
Flexible Relay Output 4	7A AC250V passive output
Flexible Relay Output 5	8A AC250V passive output
Flexible Relay Output 6	8A AC250V passive output
Case Dimensions	242mm×186mm×53mm
Panel Cutout	214mm×160mm
CT Secondary Current	Rated 5A
Working Conditions	Temperature: (-40~+70)°C Humidity: (20~93)%RH
Storage Conditions	Temperature:(-40~+70)°C
Protection Level	IP55 Gasket
Insulation Intensity	Apply AC2.2kV voltage between high voltage terminal and low voltage terminal. The leakage current is not more than 3mA within 1min.
Weight	0.85kg

4 OPERATION

4.1 INDICATORS











Parts of alarm indicators,



Alarm Type	Alarm Indicator
No Alarm	Indicator off
Warning	Slow flashing (1 time/s)
Trip Alarm	Slow flashing (1 time/s)
Shutdown Alarm	Fast flashing (5 times/s)
Trip and Stop Alarm	Fast flashing (5 times/s)



Status indicator: illuminated from crank disconnect to ETS and off during other periods.

Gens normal Indicator: It is light on when generator is normal; flashing when generator state is abnormal; off when there is no generator power.

4.2 PUSHBUTTONS

Icons	Keys	Description
	Stop	Stop running generator in Auto/Manual mode; Lamp test (press at least 3 seconds); Reset alarm in stop mode; During stopping process, press this button again to stop generator immediately.
	Start	Start genset in Manual mode.
	Manual Mode	Press this key and controller enters in Manual mode.
	Auto Mode	Press this key and controller enters in Auto mode.
	Mute/Reset Alarm	Alarming sound off; If trip alarm occurs, pressing the button at least 3 seconds can reset this alarm.
	Close	Close breaker in manual mode.
	Open	Open breaker in manual mode.
	Set/Confirm	Enter into setting interface.
	Up/Increase	1) Screen scroll; 2) Up cursor and increase value in setting menu.
	Down/Decrease	1) Screen scroll; 2) Down cursor and decrease value in setting menu.
	Left	1) Screen scroll; 2) Left move cursor in setting menu.



	Right	1) Screen scroll; 2) Right move cursor in setting menu.
	Confirm	Confirm input content in setting menu.
	Exit	1)Return to main menu; 2) Return to previous menu in setting menu.

NOTE: Press  and  simultaneously in manual mode will force generator to crank. Successful start will not be judged according to crank disconnect conditions, operator will have to crank the starter motor manually; when operator decides that the engine has fired, he/she should release the button and start output will be deactivated, safety on delay will be initiated.

WARNING: Default password is 00318, user can change it in case of others change the advanced parameters setting. Please clearly remember the password after changing. If you forget it, please contact SmartGen services and send all information in the controller page of “**ABOUT**” to us.

4.3 LCD DISPLAY

4.3.1 MAIN DISPLAY

Main screen show pages; use  to scroll the pages and  to scroll the screen.

- **Main Screen**, including as below,

Part of status display

Gen: voltage, frequency

Load: current, active power, reactive power

Bus: voltage, frequency

Engine: speed, temperature, oil pressure

NOTE: Main screen will circulatory display if without scroll operation.

- **Status**, including as below,

Status of genset and ATS

- **Engine**, including as below,

Engine speed, engine temperature, engine oil pressure, fuel level, flexible sensor 1, flexible sensor 2, battery voltage, charger voltage, engine accumulated run, accumulated start times and user A and B accumulated running time.

NOTE: If connected with J1939 engine via CANBUS port, this page also includes: coolant pressure, coolant level, fuel temperature, fuel pressure, inlet temperature, exhaust temperature, turbo pressure, total fuel consumption and so on. (Different engine with different parameters)

- **Generator**, including as below,

Phase voltage, line voltage, frequency, phase sequence, each phase current, each phase and total active power (positive and negative), each phase and total reactive power (positive and negative), each phase and total apparent power, each phase and average power factor (positive and negative), accumulated energy, earth current, unbalanced current and user A and user B accumulated energy.

▲NOTE: Power factor shows as following,

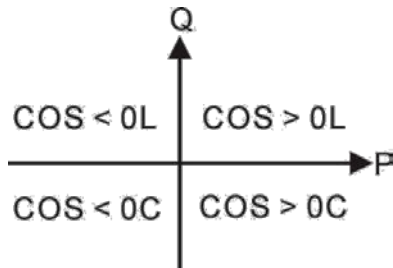

Remark:

P stands for active power

Q stands for inactive power

Power factor	Conditions	Active power	Reactive power	Remark
COS>0L	P>0,Q>0	Input	Input	Load is inductive resistance.
COS>0C	P>0,Q<0	Input	Output	Load is capacitance resistance.
COS<0L	P<0,Q>0	Output	Input	Load is equal to one under excitation generator.
COS<0C	P<0,Q<0	Output	Output	Load is equal to one over excitation generator.

Remark:

1. Input active power, generator send active power to load.
2. Output active power, load supply electricity to generator.
3. Input reactive power, generator send reactive power to load.
4. Output reactive power, load send reactive power to generator.

- **Bus**, including as below,

Phase voltage, line voltage, frequency, phase sequence

- **SNYC**, including as below,

Synchronoscope, power percentage, and MSC status

- **Alarm:**

Display all alarm information, including warn, shutdown alarm, trip shutdown and trip but not shutdown.

▲NOTE: For ECU alarms and shutdown alarms, if the alarm information is displayed, check engine according to it, otherwise, please check the generator manual according to SPN alarm code.

- **Event log**

Make records about all start/stop events (shutdown alarm, trip and stop alarm, manual /auto start or stop) and the real time when alarm occurs and genset parameters..

- **Others**, including,

Time and Date, maintenance due, input/output ports status, network settings and etc..

- **About**, including,

Issue time of software and hardware version, product PD number.

4.3.2 PARAMETERS SETTING MANUAL

Press  key for more than 3s to enter into user manual.

- Parameter

After entering the correct password (factory default password is 00318) you can enter parameter settings interface..

- Language

Selectable Chinese, English and others (default: Espanol)

- Commissioning

On load, off load or custom commissioning can be chosen. Custom commissioning can configure on load or not during commissioning, when to commissioning and select the mode after commissioning (manual mode, auto mode and stop mode).

- Clear users' accumulation

Can clear total run time A and B, total electric energy A and B.

4.3.3 PARAMETER SETTING

- Timer settings
- Engine settings
- Generator settings
- Load settings
- Breaker settings
- Temperature sensor settings
- Oil pressure sensor settings
- Liquid level sensor settings
- Flexible sensor 1
- Flexible sensor 2
- Switch input port settings
- output port settings
- Module settings
- Scheduling and maintenance settings
- GSM settings
- Synchronization settings
- Expansion module settings

 **NOTE:** press  can exist parameter setting directly.

4.4 AUTO START/STOP OPERATION

Auto mode is selected by pressing ; a LED besides the button will illuminate to confirm the operation.

Automatic Start Sequence:





- 1) When “Remote Start” is active, “Start Delay” timer is initiated;
- 2) “Start Delay” countdown will be displayed on LCD;
- 3) When start delay is over, preheat relay energizes (if configured), “preheat delay XX s” information will be displayed on LCD;
- 4) After the above delay, the Fuel Relay (if configured) is energized, and then one second later, the Start Relay is engaged. The engine is cranked for a pre-set time. If the engine fails to fire during this cranking attempt then the fuel relay and start relay are disengaged for the pre-set rest period; “crank rest time” begins and wait for the next crank attempt.
- 5) Should this start sequence continue beyond the set number of attempts, the start sequence will be terminated, the first line of LCD display will be highlighted with black and Fail to Start will be displayed.
- 6) In case of successful crank attempt, the “Safety On” timer is activated, allowing Low Oil Pressure, High Temperature, under speed and Charge Alternator Failure inputs to stabilise without triggering the fault. As soon as this delay is over, “start idle” delay is initiated (if configured).
- 7) During “start idle” delay, under speed, under frequency, under voltage alarms are inhibited. When this delay is over, “warming up” delay is initiated (if configured).
- 8) When “warming up delay” is over, if generator state is normal, its indicator will be illuminated. If voltage and frequency has reached on-load requirements, the closing relay will be energized, generator will accept load, generator power indicator will turn on, and generator will enter Normal Running state; if voltage and frequency are abnormal, the controller will initiate alarm (alarm type will be displayed on LCD alarm page).

Remark: In case of “Remote Start (off Load)”, the procedure is the same, except for step NO. 8: the closing relay will NOT be energized, generator will NOT accept load.

Automatic Stop Sequence,

- 1) When the “Remote Start” signal is removed, the Stop Delay is initiated.
- 2) Once this “stop delay” has expired, the Generator Breaker will open and the “Cooling Delay” is then initiated. After “transfer rest time”, close mains relay is energized. Generator indicator extinguish while mains indicator lights.
- 3) During “Stop Idle” Delay (if configured), idle relay is energized.
- 4) “ETS Solenoid Hold” begins, ETS relay is energized while fuel relay is de-energized, complete stop is detected automatically.
- 5) “Fail to Stop Delay” begins, complete stop is detected automatically.
- 6) When generator is stop completely, “After stop” delay will be initiated. Otherwise, fail to stop alarm is initiated (If generator is stop successfully after “fail to stop” alarm has initiated, “After stop” delay will be initiated and the alarm will be removed)
- 7) Generator is placed into its standby mode after its “After stop” delay.

4.5 MANUAL START/STOP OPERATION

- 1) **MANUAL START:** it is selected by pressing the  button; a LED besides the button will illuminate to confirm the operation; then press  button to start the gen-set; can detect crank disconnect condition and generator accelerates to high-speed running automatically. With high temperature, low oil pressure, over speed and abnormal voltage during generator running, controller can protect genset to stop quickly. Press  and  keys simultaneously to control breaker close or open. (Please refer to No.3~8 of **Automatic Start Sequence** for detail procedures, only breaker open/close ways are different).
- 2) **MANUAL STOP:** Press  can shuts down the running generators. (Please refer to No.2~7 of **Automatic Start Sequence** for detail procedures).

▲NOTE: In “manual mode”, the procedures of ATS please refer to Switch Control Procedure of generator in this manual.

4.6 SWITCH CONTROL PROCEDURES

4.6.1 MANUAL TRANSFER PROCEDURES

When controller is in **Manual** mode, the switch control procedures will start through manual transfer procedures. Users can control the loading transfer of ATS via pressing button to switch on or off.

Closing Operation: During genset normal running, press  if generator voltage and frequency have reached on-load requirements

- 1) In case of single unit running, generator closing relay outputs;
- 2) In case of running in parallel:
 - a) If bus has no voltage, then the controller will send a closing signal to other waiting parallel gensets and generator close relay will activate, this prevents other sets in the system from attempting to close their own breakers at the same time.
 - b) If bus has voltage or other gensets are already closed, the controller will adjust speed and voltage through GOV and AVR to synchronize the gensets to the bus; when synchronism requirements has been achieved, breaker close signal will be initiated and the genset will be paralleled to the bus. Once they are paralleled, the controller will control the generator to gradually accelerate and share load with other paralleled gensets.

Opening operation: Press ,

- 1) In case of single unit running, the controller sends open breaker signal.
- 2) During parallel operation, the controller will transfer load to other generators, and then send an opening signal.

4.6.2 AUTOMATIC CONTROL PROCEDURE

When controller is in auto mode, the switch control procedure is automatic control procedure.

▲NOTE: The auxiliary close input should be configured necessarily and make sure the connection is correct.

5 PROTECTIONS

5.1 WARNING ALARMS

Warning alarms does not lead to shutdown. Warning alarms types are as follows:

No	Type	Description
1	Over Speed	When the controller detects that the engine speed has exceeded the pre-set value, it will initiate a warning alarm.
2	Under Speed	When the controller detects that the engine speed has fallen below the pre-set value, it will initiate a warning alarm.
3	Loss of Speed Signal	When the controller detects that the engine speed is 0 and the action select "Warn", it will initiate a warning alarm.
4	Gen Over Frequency	When the controller detects that the genset frequency has exceeded the pre-set value, it will initiate a warning alarm.
5	Gen Under Frequency	When the controller detects that the genset frequency has fallen below the pre-set value, it will initiate a warning alarm.
6	Gen Over Voltage	When the controller detects that the generator voltage has exceeded the pre-set value, the controller will initiate a warning alarm.
7	Gen Under Voltage	When the controller detects that the genset voltage has fallen below the pre-set value, it will initiate a warning alarm.
8	Gen Over Current	When the controller detects that the genset current has exceeded the pre-set value and the action select "Warn", it will initiate a warning alarm.
9	Fail To Stop	After "fail to stop" delay, if gen-set does not stop completely, it will initiate a warning alarm.
10	Charge Alternator Failure	When the controller detects that charger voltage has fallen below the pre-set value, it will initiate a warning alarm.
11	Battery Over Volt	When the controller detects that start battery voltage has exceeded the pre-set value, it will initiate a warning alarm.
12	Battery Under Volt	When the controller detects that start battery voltage has fallen below the pre-set value, it will initiate a warning alarm.
13	Maintenance Due	When count down time is 0 and the action select "Warn", it will initiate a warning alarm.
14	Reverse Power	If reverse power detection is enabled, when the controller detects that the reverse power value (power is negative) has exceeded the pre-set value and the action select "Warn", it will initiate a warning alarm.
15	Over Power	If over power detection is enabled, when the controller detects that the over power value (power is positive) has exceeded the pre-set value and the action select "Warn", it will initiate a warning alarm.
16	ECU Warn	If an error message is received from ECU via J1939, it will initiate a warning alarm.
17	Switch Fail Warn	When the controller detects that the breaker close or open failure occurs, or input port did not set Gen Close Status input, it will initiate a warning alarm.
18	Temperature Sensor Open Circuit	When the controller detects that the temperature sensor is open circuit and the action select "Warn", it will initiate a warning alarm.
19	High Temperature	When the controller detects that engine temperature has exceeded the pre-set value, it will initiate a warning alarm.

No	Type	Description
20	Low Temperature	When the controller detects that engine temperature has fallen below the pre-set value, it will initiate a warning alarm.
21	Oil Pressure Sensor Open Circuit	When the controller detects that the oil pressure sensor is open circuit and the action select "Warn", it will initiate a warning alarm.
22	Low Oil Pressure	When the controller detects that the oil pressure has fallen below the pre-set value, it will initiate a warning alarm.
23	Level Sensor Open Circuit	When the controller detects that the level sensor is open circuit and the action select "Warn", it will initiate a warning alarm.
24	Low Fuel Level	When the controller detects that the fuel level has fallen below the pre-set value, it will initiate a warning alarm.
25	Flexible Sensor 1 Open Circuit	When the controller detects that the flexible sensor 1 is open circuit and the action select "Warn", it will initiate a warning alarm.
26	Flexible Sensor 1 High	When the controller detects that the sensor 1 value has exceeded the pre-set upper limit value, it will initiate a warning alarm.
27	Flexible Sensor 1 Low	When the controller detects that the sensor 1 value has fallen below the pre-set lower limit value, it will initiate a warning alarm.
28	Flexible Sensor 2 Open Circuit	When the controller detects that the flexible sensor 2 is open circuit and the action select "Warn", it will initiate a warning alarm.
29	Flexible Sensor 2 High	When the controller detects that the sensor 2 value has exceeded the pre-set upper limit value, it will initiate a warning alarm.
30	Flexible Sensor 2 Low	When the controller detects that the sensor 2 value has fallen below the pre-set lower limit value, it will initiate a warning alarm.
31	Digital Input	When digit input port is set as warning and the alarm is active, it will initiate a warning alarm.
32	GSM Communication Failure	When GSM is active and GSM module did not been detected by the controller, controller will initiate a warning alarm.
33	Earth Fault	If earth fault detection is enabled, when the controller detects that the earth fault current has exceeded the pre-set value and the action select "Warn", it will initiate a warning alarm.
34	Imbalance Current	When imbalance current detection enabled and controller detects that unbalanced current value exceeded pre-set value, the action select "Warn", it will initiate a warning alarm.
35	Fail to sync	When the controller does not detect synchronization signal within the pre-set synchronization time, it will initiate a warning alarm.
36	MSC Too Few Sets	When the controller detects fewer modules on the MSC link than the minimum number configured in the unit, it will initiate a warning alarm. There are 2 possible reasons: a) Communication line between the controllers disconnects, which interrupts communication. b) Other parallel gen-sets controllers have not been powered on.
37	Loss of Excitation	When loss of excitation detection is active and the controller detects that the genset negative reactive power has exceeded the pre-set value, it will initiate a warning alarm.

5.2 SHUTDOWN ALARMS

When controller detects shutdown alarm, it will send signal to open breaker and shuts down generator.

Shutdown alarms as following:

No	Type	Description
1	Emergency Stop	When the controller detects an emergency stop alarm signal, it will initiate a shutdown alarm.
2	Over Speed	When the controller detects that the generator speed has exceeded the pre-set value, it will initiate a shutdown alarm.
3	Under Speed	When the controller detects that the generator speed has fallen below the pre-set value, it will initiate a shutdown alarm.
4	Loss of Speed Signal	When the controller detects that the engine speed is 0 and the action select "Shutdown", it will initiate a shutdown alarm.
5	Gen Over Frequency	When the controller detects that the genset frequency has exceeded the pre-set value, it will initiate a shutdown alarm.
6	Gen Under Frequency	When the controller detects that the genset frequency has fallen below the pre-set value, it will initiate a shutdown alarm.
7	Gen Over Voltage	When the controller detects that the generator voltage has exceeded the pre-set value, the controller will initiate a shutdown alarm.
8	Genset Under Voltage	When the controller detects that the genset voltage has fallen below the pre-set value, it will initiate a shutdown alarm.
9	Fail To Start	If the engine does not fire after the pre-set number of attempts, it will initiate a shutdown alarm.
10	Gen Over Current	When the controller detects that the genset current has exceeded the pre-set value and the action select "Shutdown", it will initiate a shutdown alarm.
11	Maintenance Due	When count down time is 0 and the action select "Shutdown", it will initiate a shutdown alarm.
12	ECU Shutdown	If an error message is received from ECU via J1939, it will initiate a shutdown alarm.
13	ECU Fail	If the module does not detect the ECU data via J1939, it will initiate a shutdown alarm.
14	Reverse Power	If reverse power detection is enabled, when the controller detects that the reverse power value (power is negative) has exceeded the pre-set value and the action select "Shutdown", it will initiate a shutdown alarm.
15	Over Power	If over power detection is enabled, when the controller detects that the over power value (power is positive) has exceeded the pre-set value and the action select "Shutdown", it will initiate a shutdown alarm.
16	Temperature Sensor Open Circuit	When the controller detects that the temperature sensor is open circuit and the action select "Shutdown", it will initiate a shutdown alarm.
17	High Temperature	When the controller detects that engine temperature has exceeded the pre-set value, it will initiate a shutdown alarm.
18	Oil Pressure Open Circuit	When the controller detects that the oil pressure sensor is open circuit and the action select "Shutdown", it will initiate a shutdown alarm.
19	Low Oil Pressure	When the controller detects that the oil pressure has fallen below the pre-set value, it will initiate a shutdown alarm.



No	Type	Description
20	Level Sensor Open Circuit	When the controller detects that the level sensor is open circuit and the action select "Shutdown", it will initiate a shutdown alarm.
21	Flexible Sensor 1 Open Circuit	When the controller detects that the flexible sensor 1 is open circuit and the action select "Shutdown", it will initiate a shutdown alarm.
22	Flexible Sensor 1 High	When the controller detects that the sensor 1 value has exceeded the pre-set upper limit value, it will initiate a shutdown alarm.
23	Flexible Sensor 1 Low	When the controller detects that the sensor 1 value has fallen below the pre-set lower limit value, it will initiate a shutdown alarm.
24	Flexible Sensor 2 Open Circuit	When the controller detects that the flexible sensor 2 is open circuit and the action select "Shutdown", it will initiate a shutdown alarm.
25	Flexible Sensor 2 High	When the controller detects that the sensor 2 value has exceeded the pre-set upper limit value, it will initiate a shutdown alarm.
26	Flexible Sensor 2 Low	When the controller detects that the sensor 2 value has fallen below the pre-set lower limit value, it will initiate a shutdown alarm.
27	Digital Input	When digit input port is set as shutdown and the alarm is active, it will initiate a shutdown alarm.
28	Earth Fault	When the controller detects that the earth fault current has exceeded the pre-set value and the action select "Shutdown", it will initiate a shutdown alarm.
29	Imbalance Current	When Imbalance Current detection enabled and the controller detects the imbalance current has exceeded the pre-set value and the action select "Shutdown" it will initiate a shutdown alarm.
30	MSC Too Few Sets	When the controller detects fewer modules on the MSC link than the minimum number configured in the unit, it will initiate a shutdown alarm. There are 2 possible reasons: a) Communication line between the controllers disconnects, which interrupts communication. b) Other parallel gen-sets controllers have not been powered on.
31	MSC ID Error	When the controller detects the same ID on the MSC Bus, it will initiate a shutdown alarm.
32	Gen Phase Sequence Wrong	When the controller detects a phase sequence wrong, it will initiate a shutdown alarm.
33	Volt Bus Phase Sequence Wrong	When the controller detects a bus phase sequence wrong, it will initiate a shutdown alarm.
34	Volt Bus Error	After synchronized-closing, when the controller detects the voltage difference between generator and bus, it will initiate a shutdown alarm.
35	Loss of Excitation	When the controller detects that the genset negative reactive power has exceeded the pre-set value, it will initiate a shutdown alarm.

5.3 TRIP AND STOP ALARMS

Once trip and stop occurred the controller will start the cooling delay and allow the engine to cool before shutting down the engine.

No	Type	Description
1	Gen Over Current	When the controller detects that the genset current has exceeded the pre-set value and the action select "Trip and Stop", it will initiate a trip and stop alarm.
2	Maintenance Due	When count down time is 0 and the action select "Trip and Stop", it will initiate a trip and stop alarm.
3	Reverse Power	If reverse power detection is enabled, when the controller detects that the reverse power value (power is negative) has exceeded the pre-set value and the action select "Trip and Stop", it will initiate a trip and stop alarm.
4	Over Power	If over power detection is enabled, when the controller detects that the over power value (power is positive) has exceeded the pre-set value and the action select "Trip and Stop", it will initiate a trip and stop alarm.
5	Digital Input	When digit input port is set as "Trip and Stop" and the alarm is active, it will initiate a trip and stop alarm.
6	Earth Fault	If earth fault detection is enabled, when the controller detects that the earth fault current has exceeded the pre-set value and the action select "Trip and Stop", it will initiate a trip and stop alarm.
7	Imbalance Current	If earth imbalance current detection is enabled, when the controller detects the imbalance current has exceeded the pre-set value and the action select "Trip and Stop", it will initiate a trip and stop alarm.
8	Loss of Excitation	If loss of excitation fault detection is enabled, when the controller detects that the genset negative reactive power has exceeded the pre-set value, it will initiate a trip and stop alarm.
9	Mains Over Freq	When the controller detects that the mains frequency has exceeded the pre-set value, it will initiate a trip and stop alarm.
10	Mains Under Freq	When the controller detects that the mains frequency has fallen below the pre-set value, it will initiate a trip and stop alarm.
11	Mains Over Voltage	When the controller detects that the mains voltage has exceeded the pre-set value, it will initiate a trip and stop alarm.
12	Mains Under Voltage	When the controller detects that the mains voltage has fallen below the pre-set value, it will initiate a trip and stop alarm.
13	Mains ROCOF	When the controller detects that the ROCOF (rate of change of frequency) has exceeded the pre-set value, it will initiate a trip and stop alarm.
14	Mains Vector Shift	When the controller detects that vector shift value has exceeded the pre-set value, it will initiate a trip and stop alarm.

5.4 TRIP ALARM

On initiation of the trip condition the controller will de-energize the 'Close Generator' Output without stop the generator.

Trip alarm as following,

No	Type	Description
1	Gen Over Current	When the controller detects that the genset current has exceeded the pre-set value and the action select "Trip", it will initiate a trip alarm.
2	Reverse Power	If reverse power detection is enabled, when the controller detects that the reverse power value (power is negative) has exceeded the pre-set value and the action select "Trip", it will initiate a trip alarm.
3	Over Power	If over power detection is enabled, when the controller detects that the over power value (power is positive) has exceeded the pre-set value and the action select "Trip", it will initiate a trip alarm.
4	Digital Input	When digit input port is set as "Trip" and the alarm is active, it will initiate a trip alarm.
5	Earth Fault	If earth fault detection is enabled, when the controller detects that the earth fault current has exceeded the pre-set value and the action select "Trip", it will initiate a trip alarm.
6	Imbalance Current	If imbalance current detection is enabled, when the controller detects the imbalance current has exceeded the pre-set value and the action select "Trip", it will initiate a trip alarm.
7	Loss of Excitation	If loss of excitation fault detection is enabled, when the controller detects that the genset negative reactive power has exceeded the pre-set value, it will initiate a trip alarm.

6 WIRING CONNECTION

HGM8151 controller's back panel as following:

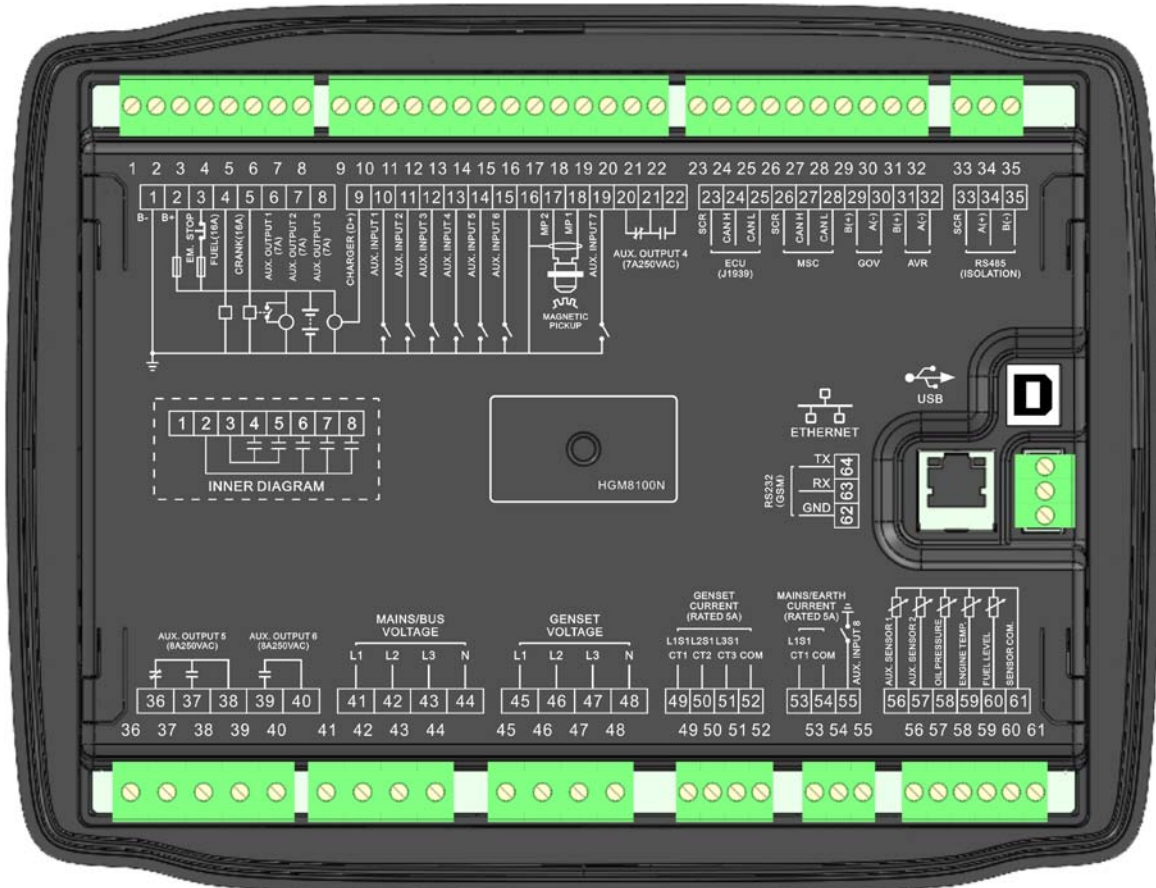

Description of terminal connection:

No.	Functions	Cable Size	Remark	
1	B-	2.5mm ²	Connected with negative of starter battery.	
2	B+	2.5mm ²	Connected with positive of starter battery. If wire length is over 30m, better to double wires in parallel. Max. 20A fuse is recommended.	
3	Emergency stop	2.5mm ²	Connected with B+ via emergency stop button.	
4	Fuel relay	1.5mm ²	B+ is supplied by 3 points, rated 16A	
5	Crank	1.5mm ²	B+ is supplied by 3 points, rated 16A	Connected to starter coil Details see form 2
6	Aux. output 1	1.5mm ²	B+ is supplied by 2 points, rated 7A	
7	Aux. output 2	1.5mm ²	B+ is supplied by 2 points, rated 7A	
8	Aux. output 3	1.5mm ²	B+ is supplied by 2 points, rated 7A	Details see form 3
9	Charger (D+)	1.0mm ²	Connected with charger's D+ (WL) terminals. Be hanging in the air If there is no this terminal.	
10	Aux. input 1	1.0mm ²	Ground connected is active (B-)	
11	Aux. input 2	1.0mm ²	Ground connected is active (B-)	
12	Aux. input 3	1.0mm ²	Ground connected is active (B-)	Details see form 3
13	Aux. input 4	1.0mm ²	Ground connected is active (B-)	



No.	Functions	Cable Size	Remark	
14	Aux. input 5	1.0mm ²	Ground connected is active (B-)	
15	Aux. input 6	1.0mm ²	Ground connected is active (B-)	
16	Magnetic Pickup	0.5mm ²	Connected with Speed sensor, shielding line is recommended. (B-) has already connected with speed sensor 2.	
17	MP2			
18	MP1			
19	Aux. input 7	1.0mm ²	Ground connected is active (B-)	Details see form 3
20	Aux. output 4	1.5mm ²	Normally close outputs, rated 7A	Details see Form 2
21			Public points of relay	
22			Normally open outputs, rated 7A	
23	ECU CAN COM(GND)	/	Impedance-120Ω shielding wire is recommended, its single-end earthed.	
24	ECU CAN H	0.5mm ²		
25	ECU CAN L	0.5mm ²		
26	MSC CAN COM(GND)	/	Impedance-120Ω shielding wire is recommended, its single-end earthed.	
27	MSC CAN H	0.5mm ²		
28	MSC CAN L	0.5mm ²		
29	GOV B(+)	0.5mm ²	Shielding line is recommended. Shielding layer connect to earth at GOV end.	
30	GOV A(-)	0.5mm ²		
31	AVR B(+)	0.5mm ²	Shielding line is recommended. Shielding layer connect to earth at AVR end.	
32	AVR A(-)	0.5mm ²		
33	RS485 COM(GND)	/	Impedance-120Ω shielding wire is recommended, its single-end earthed.	
34	RS485+	0.5mm ²		
35	RS485-	0.5mm ²		
36	Aux. output 5	2.5mm ²	Normally close outputs, rated 8A	Details see form 2
37		2.5mm ²	Normally open outputs, rated 8A	
38		2.5mm ²	Public points of relay	
39		2.5mm ²	Normally open outputs, rated 8A	
40		2.5mm ²	Public points of relay	
41	Bus A-phase voltage input	1.0mm ²	Connected to A-phase of bus (2A fuse is recommended)	
42	Bus B-phase voltage input	1.0mm ²	Connected to B-phase of bus (2A fuse is recommended)	
43	Bus C-phase voltage input	1.0mm ²	Connected to C-phase of bus (2A fuse is recommended)	
44	Bus N-wire input	1.0mm ²	Connected to N-wire of mains	
45	Gen-set A-phase voltage input	1.0mm ²	Connected to A-phase of gen-set (2A fuse is recommended)	
46	Gen-set B-phase voltage input	1.0mm ²	Connected to B-phase of gen-set (2A fuse is recommended)	
47	Gen-set C-phase voltage input	1.0mm ²	Connected to C-phase of gen-set (2A fuse is recommended)	



No.	Functions	Cable Size	Remark	
48	Gen-set N-wire input	1.0mm ²	Connected to N-wire of gen-set	
49	CT A-phase input	1.5mm ²	Outside connected to secondary coil of current transformer(rated 5A)	
50	CT B-phase input	1.5mm ²	Outside connected to secondary coil of current transformer(rated 5A)	
51	CT C-phase input	1.5mm ²	Outside connected to secondary coil of current transformer(rated 5A)	
52	CT COM	1.5mm ²	See following installation instruction	
53	Reserved	/		
54		/		
55	Aux. Input 8	1.0mm ²	Ground connected is active (B-)	Details see form 3
56	Aux. sensor 1	1.0mm ²	Connect to temperature, oil pressure or fuel level sensors.	Details see form 4
57	Aux. sensor 2	1.0mm ²		
58	Oil pressure	1.0mm ²	Connect to oil pressure sensor.	
59	Engine Temp.	1.0mm ²	Connect to temperature Sensor.	
60	Fuel level	1.0mm ²	Connect to fuel level sensor.	
61	Sensor COM	/	A public terminal of sensor, (B-) has already connected internal.	
62	RS232 COM(GND)	0.5 mm ²	Connect to GSM module	
63	RS232 RX	0.5 mm ²		
64	RS232 TX	0.5 mm ²		

▲ NOTE: USB ports in controller rear panel are configurable parameter ports, user can directly program controller via PC.

▲ NOTE: ETHERNET ports in controller rear panel are network monitoring ports, user can directly monitor controller via PC.

7 SCOPES AND DEFINITIONS OF PROGRAMMABLE PARAMETERS

7.1 CONTENTS AND SCOPES OF PARAMETERS

Form 1

No.	Items	Parameters	Defaults	Description
Timer Setting				
1	Start Delay	(0~3600)s	5	Time from remote start signal is active to start genset.
2	Stop Delay	(0~3600)s	30	Time from remote start signal is inactive to stop genset.
3	Preheat Delay	(0~3600)s	0	Time of pre-powering heat plug before starter is powered up.
4	Cranking Time	(3~60)s	8	Time of starter power on
5	Crank Rest Time	(3~60)s	10	The waiting time before second power up when engine start fail.
6	Safety On Delay	(0~3600)s	10	Alarms for low oil pressure, high temperature, under speed, under frequency /voltage, charge fail are inactive.
7	Start Idle Time	(0~3600)s	10	Idle running time of genset when starting.
8	Warming Up Time	(0~3600)s	30	Warming up time between genset switch on and high speed running.
9	Cooling Time	(0~3600)s	60	Radiating time before genset stop, after it unloads.
10	Stop Idle Time	(0~3600)s	10	Idle running time when genset stop.
11	ETS Solenoid Hold	(0~3600)s	20	Stop electromagnet's power on time when genset is stopping.
12	Fail to Stop Delay	(0~3600)s	0	Time between ending of genset idle delay and stopped when "ETS time" is set as 0; Time between ending of ETS hold delay and stopped when "ETS Hold output time" is not 0.
13	After Stop Time	(0~3600)s	0	Time between genset stopped and standby.
Engine Setting				
1	Engine Type	(0~39)	0	Default: Conventional Engine(not J1939) When connected to J1939 engine, choose the corresponding type.
2	Flywheel Teeth	(10~300)	118	Tooth number of the engine, for judging of starter separation conditions and inspecting of engine speed. See the installation instructions.
3	Rated Speed	(0~6000) r/min	1500	Offer standard to judge over/under/loading speed.
4	Loading Speed	(0~100)%	90	Setting value is percentage of rated speed. Controller detects when it is ready to load. It won't switch on when speed is under loading speed.
5	Loss of Speed Signal	(0~3600)s	5	Time from detecting speed is 0 to confirm the action.



No.	Items	Parameters	Defaults	Description
6	Loss of Speed Signal Action	(0~1)	0	0:Warn; 1:Shutdown
7	Over Speed Shutdown	(0~200)%	114	Setting value is percentage of rated speed and delay value (over speed shutdown default: 2s and under speed shutdown default: 3s) also can be set.
8	Under Speed Shutdown	(0~200)%	80	
9	Over Speed Warn	(0~200)%	110	Setting value is percentage of rated speed, return value (over speed default: 108 and under speed default: 90) and delay value (default: 5s) also can be set.
10	Under Speed Warn	(0~200)%	86	
11	Battery Rated Voltage	(0~60.0)V	24.0	Standard for detecting of over/under voltage of battery.
12	Battery Over Volts Alarm	(0~200)%	120	Setting value is percentage of rated voltage of battery, delay value (default: 60s) and return value (over voltage default: 115 and under voltage default: 90) also can be set.
13	Battery Under Volts Alarm	(0~200)%	85	
14	Charge Alt Fail	(0~60.0)V	8.0	In normal running, when charger D+(WL) voltage under this value, charge failure alarms.
15	Start Attempts	(1~10) times	3	Max. Crank times of crank attempts. When reach this number, controller will send start failure signal.
16	Crank Disconnect	(0~6)	2	See form 5 There are 3 conditions of disconnecting starter with engine. Each condition can be used alone and simultaneously to separating the start motor and genset as soon as possible.
17	Disconnect Generator Freq	(0~200)%	30	Setting value is percentage of gen rated frequency. When generator frequency higher than the set value, starter will be disconnected. See the installation instruction.
18	Disconnect Engine Speed	(0~200)%	30	Setting value is percentage of rated speed. When generator speed is higher than the set value, starter will be disconnected. See the installation instruction.
19	Disconnect Oil Pressure	(0~1000)kPa	200	When generator oil pressure higher than the set value, starter will be disconnected. See the installation instruction.
Generator Setting				
1	AC System	(0~3)	0	0: 3P4W; 1: 3P3W; 2: 2P3W; 3: 1P2W.
2	Poles	(2-64)	4	Numbers of generator pole, used for calculating starter rotate speed when without speed sensor.
3	Rated Voltage	(30~30000)V	230	To offer standards for detecting of gens'



No.	Items	Parameters	Defaults	Description
				over/under voltage and loading voltage. (It is primary voltage when using voltage transformer).
4	Loading Voltage	(0~200)%	90	Setting value is percentage of generator rated voltage. When gens voltage under load voltage, won't enter into normally running, during the period of when controller ready to detect loading.
5	Rated Frequency	(10.0-75.0)Hz	50.0	To offer standards for detecting of over/under/load frequency.
6	Loading Frequency	(0~200)%	90	Setting value is percentage of generator rated frequency. When generator frequency under load frequency, it won't enter into normal running.
7	Volt. Trans.(PT)	(0~1)	0	0: Disable; 1:Enable
8	Over Volt. Shutdown	(0~200)%	120	Setting value is percentage of generator rated volt. Delay value (default: 3s) also can be set.
9	Under Volt. Shutdown	(0~200)%	80	
10	Over Freq. Shutdown	(0~200)%	114	Setting value is percentage of generator rated freq. Delay value (over frequency default: 2s and under frequency default: 3s) also can be set.
11	Under Freq. Shutdown	(0~200)%	80	
12	Over Volt. Warn	(0~200)%	110	Setting value is percentage of generator rated volt. Delay value (default: 5s) and return value (over volt default: 108 and under volt default: 86) also can be set.
13	Under Volt. Warn	(0~200)%	84	
14	Over Freq. Warn	(0~200)%	110	Setting value is percentage of gens rated freq. Delay value (default: 5s) and return value (over frequency default: 108 and under frequency default: 86) also can be set.
15	Under Freq. Warn	(0~200)%	84	
Generator Load Setting				
1	Current Trans.	(5~6000)/5	500	The ratio of external CT
2	Rated Full-load Current	(5~6000)A	500	Generator's rated current, standard of load current.
3	Rated Power	(0-6000)kW	276	Generator's rated power, standard of load power.
4	Overload Current	(0~200)%	120	Setting value is percentage of generator rated full-load current. Delay value also can be set as definite time limit or inverse time limit.
5	Over Power	(0~200)%	110	Setting value is percentage of generator rated active power. Delay value (default: 30s) and action (default: trip and stop) can be set.
6	Reverse Power	(0~200)%	10	Setting value is percentage of generator rated active power. Delay value (default:



No.	Items	Parameters	Defaults	Description
				10s) and action (default: trip and stop) can be set.
7	Earth Fault	(0~1)	0	0: Disable 1: Enable.
8	Imbalance Current	(0~1)	0	0: Disable 1: Enable.
9	Loss of Excitation	(0~200)%	20%	Setting value is percentage of generator rated reactive power. Delay value (default: 5s) and action (default: trip) can be set.
Switch Setting				
1	Close Time	(0~20.0)s	5.0	Pulse width of mains/generator switch on. When it is 0, means output constantly.
2	Open Time	(0~20.0)s	3.0	Pulse width of mains/ generator switch off.
Module Setting				
1	Power On Mode	(0~2)	0	0: Stop mode 1: Manual mode 2: Auto mode
2	Module Address	(1~254)	1	Controller's address during remote monitoring.
3	Stop Bit	(0~1)	0	0: 2 stop bits; 1: 1 stop bit
4	Language	(0~2)	0	0: Simplified Chinese 1: English 2: Others
5	Password	(0~65535)	00318	For entering parameters setting.
6	Temp. Unit Select	(0-1)	0	0: °C 1: °F
7	Pressure Unit Select	(0-2)	0	0: kPa; 1: Psi; 2: Bar.
8	Unparallel Mode Enable	(0-1)	0	0: Disable; 1: Enable
9	Date and Time			Set the module's date and time.
10	Ethernet Enable	(0~1)	1	0: Disable; 1: Enable All Ethernet setting changes (e.g. IP address, Subnet mask) are active after controller re-power on.
GSM Setting				
1	GSM Enable	(0-1)	0	0: Disable; 1: Enable
2	Phone Number Set	Max. 20 bit		Phone number needed to be added area code of region or country. e.g. China 8613666666666
Scheduling And Maintenance Setting				
1	Scheduled Run	(0~1)	0	0: Disable; 1: Enable
2	Scheduled Not Run	(0~1)	0	0: Disable; 1: Enable
3	Maintenance	(0~1)	0	0: Disable; 1: Enable
Analog Sensors Setting				
Temperature Sensor				
1	Curve Type	(0~15)	7	SGX
2	Open Circuit Action	(0~2)	0	0: Warn 1: Shutdown 2: No action
3	High Temp. Shutdown	(0-300)°C	98	Shutdown when sensor temperature higher than this value. Detecting only after safety delay is over. The delay value (default: 3s) also can be set.
4	High Temp Warn	(0-300)°C	95	Warn when sensor temperature higher than



No.	Items	Parameters	Defaults	Description
				this value. Detecting only after safety delay is over. The delay value (default: 5s) and return value (default: 93) also can be set.
5	Low Temp. Warn	(0~1)	0	0: Disable; 1: Enable
Oil Pressure Sensor				
1	Curve Type	(0~15)	7	SGX
2	Open Circuit Action	(0~2)	0	0: Warn 1: Shutdown 2: No action
3	Low OP Shutdown	(0~1000)kPa	103	Shutdown alarm will be sent when oil pressure of external oil pressure sensor lower than this value. Detecting only after safety delay is over. The delay value (default: 3s) also can be set.
4	Low OP Warn	(0~1000)kPa	124	Warn when oil pressure of external oil pressure sensor lower than this value. Detecting only after safety delay is over. The delay value (default: 5s) and return value (default: 138) also can be set.
Fuel Level Sensor				
1	Curve Type	(0~15)	0	Not used.
2	Open Circuit Action	(0~2)	0	0: Warn; 1: Alarm Shutdown; 2: No Action
3	Low Fuel Level Warn	(0~300)%	10	When liquid level value of the external liquid level sensor is lower than the set value, low liquid level warns will be initiated. This value is always detecting. The delay value (default: 5s) and return value (default: 15) also can be set.
Flexible Sensor 1				
1	Flexible Sensor 1 Setting	(0~1)	0	0: Disable 1: Enable; (can be set as temperature/pressure/liquid lever sensor).
Flexible Sensor 2				
1	Flexible Sensor 2 Setting	(0~1)	0	0: Disable; 1: Enable; (can be set as temperature/pressure/liquid lever sensor).
Digital Input Ports				
Digital Input Port 1				
1	Contents Setting	(0~55)	31	Remote start (demand).
2	Active Type	(0~1)	0	0: Closed to active 1: Open to active
Digital Input Port 2				
1	Contents Setting	(0~55)	27	Low oil pressure shutdown
2	Active Type	(0~1)	0	0: Closed to active 1: Open to active
Digital Input Port 3				
1	Contents Setting	(0~55)	26	High temperature shutdown
2	Active Type	(0~1)	0	0: Closed to active 1: Open to active
Digital Input Port 4				

No.	Items	Parameters	Defaults	Description
1	Contents Setting	(0~55)	13	Gen Closed.5
2	Active Type	(0~1)	0	0: Closed to active 1: Open to active
Digital Input Port 5				
1	Contents Setting	(0~55)	0	User defined.
2	Active Type	(0~1)	0	0: Closed to active 1: Open to active
3	Active Range	(0~3)	3	0: From safety on 1: From starting 2: Always active 3: Deactive
4	Active Actions	(0~4)	4	0: Warn; 1: Shutdown; 2: Trip and stop 3: Trip 4: Indication
5	Delay	(0~20.0)s	2.0	Time from detecting input port is active to confirm.
6	Description			LCD display detailed contents when the input is active.
Digital Input Port 6				
1	Contents Setting	(0~55)	44	First priority.
2	Active Type	(0~1)	0	0: Closed to active 1: Open to active
Digital Input Port 7				
1	Contents Setting	(0~55)	0	User defined. See form 3
2	Active Type	(0~1)	0	0: Closed to active 1: Open to active
3	Active Range	(0~3)	3	0: From safety on 1: From starting 2: Always active 3: Deactive
4	Active Actions	(0~4)	4	0: Warn; 1: Shutdown; 2: Trip and stop 3: Trip 4: Indication
5	Active Delay	(0~20.0)s	2.0	Time from detecting input port is active to confirm.
6	Description			LCD display detailed contents when the input is active.
Relay Output Ports				
Relay Output Port 1				
1	Contents Setting	(0~299)	44	Generator OK.
2	Output Type	(0~1)	0	0: Normally open; 1: Normally close
Relay Output Port 2				
1	Contents Setting	(0~299)	48	Common Alarm.
2	Output Type	(0~1)	0	0: Normally open; 1: Normally close
Relay Output Port 3				
1	Contents Setting	(0~299)	38	Energize to Stop.
2	Output Type	(0~1)	0	0: Normally open; 1: Normally close
Relay Output Port 4				
1	Contents Setting	(0~299)	35	Idle Control.
2	Output Type	(0~1)	0	0: Normally open;

No.	Items	Parameters	Defaults	Description
				1:Normally close
Relay Output Port 5				
1	Contents Setting	(0~299)	30	Gen Open Output.
2	Output Type	(0~1)	0	0:Normally open; 1:Normally close
Relay Output Port 6				
1	Contents Setting	(0~299)	29	Close Gen Output.
2	Output Type	(0~1)	0	0:Normally open; 1:Normally close
Sync Setting -Basic				
1	Dead Bus Volt	(10-50)V	30	It is considered Bus no power when Bus voltage is lower than dead Bus voltage.
2	Voltage Difference	(0-30)V	3	It is considered voltage synchronization when the voltage difference between Generator and Bus is lower than synchronization voltage difference.
3	Positive Freq Difference	(0-2.0)Hz	0.2	It is considered frequency synchronization when the frequency difference between Generator and Bus is less than Check Up Freq but more than Check Low Freq .
4	Negative Freq Difference	(0-2.0)Hz	0.1	
5	Phase Angle Difference	(0-20)°	10	It is considered phase synchronization when the initial phase difference between gen and bus is lower than synchronizing phase angles difference.
6	Difference Frequency	(0-1.00)Hz	0.10	Adjust generator frequency and enable it greater than Bus frequency.
7	MSC ID	(0-31)	1	It is the ID mark of the MSC communication internet. MSC ID of the communication network should be unique.
8	MSC Priority	(0-31)	0	Smaller values represent higher priorities.
9	Full-load kW rating	(0-20000)kW	276	Used for load sharing.
10	Full-load kVar rating	(0-20000)kvar	210	Used for load sharing.
11	Baud Rate	(0-3)	1	0: 500kbps; 1: 250kbps; 2: 125kbps; 3: 50kbps.
12	Scheduled Run PCT	(0-100)%	80	Schedule the load value of other genset when start on demand.
13	Scheduled Stop PCT	(0-100)%	50	Schedule the load value of other genset when start on demand.
14	Load Ramp Rate	(0.1-100.0)%	3.0	Speed rate(%/s) of genset load/load shedding
15	Load Ramp Point	(0.1-40.0)%	10.0	
16	Load Ramp Delay	(0-30)s	0	
17	Starting Options	(0-1)	1	0: Start All Sets; 1: Start Sets as Load Requires
18	MSC Modules	(2-10)	2	
19	MSC Too Few Modules Action	(0-2)	1	Action Type: 0: No Action; 1: Warn; 2: Trip.



No.	Items	Parameters	Defaults	Description
	Type			
20	Balance Engine Hours	(1-1000)Hours	Disable	When the input is active, the controller will start/stop the genset automatically according to the running time and the pre-set balanced running time.
21	Fail to Sync Delay	(5.0-300.0)s	60.0	When the controller detects no Sync signal during the preset delay, it will send corresponding alarm signal according to the action type. Action Type: 0: Warn; 1: Trip.
22	Fail to Sync Action	(0-1)	0	
23	NEL Trip Enable	(0-1)	0	0: Disable 1: Enable; Details of function description please see the following.
24	NEL Trip Value 1	(0-200)%	90%	
25	NEL Trip Delay 1	(0-3600)s	5	
26	NEL Trip Value 2	(0-200)%	100%	
27	NEL Trip Delay 2	(0-3600)s	1	
28	NEL Auto Reconnection Enable	(0-1)	0	
29	NEL Auto Reconnection Value	(0-200)%	50%	
30	NEL Auto Reconnection Delay	(0-3600)s	5	
31	NEL Number	(1-3)	3	
Sync Setting - GOV				
1	Output Type	(0-1)	1	0: Relay output; 1: Analog Voltage Output
2	Output Reverse	(0-1)	0	0: Disable; 1: Enable.
3	Loading Action	(0-2)	1	0: None; 1: Adjust to Rated Frequency; 2: Adjust to Center Point
4	Center Voltage SW1	(0-10.0)	0	Default central voltage: 0V.
5	Voltage Range SW2	(0-10.0)	2.0	Default volt. range: (-1.5~+1.5)V
6	Sync Gain	(0-500)	20	Adjust and control before paralleling.
7	Sync Stability	(0-2000)	20	Adjust and control before paralleling.
8	Load Control Gain	(0-500)	20	Adjust and control after paralleling.
9	Load Control Stability	(0-2000)	20	Adjust and control after paralleling.
Sync Setting - AVR				
1	Output Type	(0-1)	1	0: Relay output; 1: Analog Voltage Output
2	Output Reverse	(0-1)	0	0: Disable; 1: Enable.
3	Loading Action	(0-2)	1	0: None; 1: Adjust to Rated Frequency; 2: Adjust to Center Point
4	Centre Voltage SW1	(0-10.0)	0	Default central voltage: 0V.
5	Voltage Range SW2	(0-10.0)	2.0	Default volt. range: (-1.5~+1.5)V
6	Sync Control Gain	(0-500)	20	Adjust and control before paralleling.



No.	Items	Parameters	Defaults	Description
7	Sync Control Stability	(0-2000)	20	Adjust and control before paralleling.
8	Load Control Gain	(0-500)	20	Adjust and control after paralleling.
9	Load Control Stability	(0-2000)	20	Adjust and control after paralleling.
Mains Split Setting				
1	AC System	(0~3)	0	0: 3P4W; 1: 3P3W; 2: 2P3W; 3: 1P2W.
2	Rated Voltage	(30~30000)V	230	To offer standards for detecting of mains' over/under voltage and loading voltage. (It is primary voltage when using voltage transformer; it is line voltage when AC system is 3P3W while it is phase voltage when using other AC system).
3	Mains Rated Frequency	(10.0~75.0)Hz	50.0	To offer standards for detecting of over/under/load frequency.
4	Mains Volt. Trans.(PT)	(0-1)	0	0: Disable ; 1: Enable
5	Mains Over Voltage	(0-200)%	105%	Setting value is percentage of mains rated volt. Delay value (default: 0.1s) and alarm action (default: trip and stop) also can be set.
6	Mains Under Voltage	(0-200)%	95%	
7	Mains Over Frequency	(0-200)%	105%	
8	Mains Under Frequency	(0-200)%	95%	Setting value is mains rated frequency's percentage. Delay value(default: 0.1s) and alarm action (default: trip and stop) also can be set.
9	ROCOF	(0-1.00)Hz/s	0.20	Setting value is mains' rate of change of frequency, and alarm action (default: trip and stop) and delay value (default: 0.1s) also can be set.
10	Vector Shift	(0-20.0)°	6.0	Setting value is phase angle's change rate of mains voltage waveform, and alarm action (default: trip and stop) and delay value (default: 0.1s) also can be set.

7.2 ENABLE DEFINITION OF PROGRAMMABLE OUTPUT PORTS

Form 2

No.	Type	Description
0	Not Used	
1	Custom Period 1	Details of function description please see the following.
2	Custom Period 2	
3	Custom Period 3	
4	Custom Period 4	
5	Custom Period 5	
6	Custom Period 6	
7	Custom Combined 1	
8	Custom Combined 2	
9	Custom Combined 3	
10	Custom Combined 4	
11	Custom Combined 5	
12	Custom Combined 6	
13	Reserved	
14	Reserved	
15	Reserved	
16	Reserved	
17	Air Flap Control	Action when over speed shutdown and emergence stop. It also can close the air inflow to stop the engine as soon as possible.
18	Audible Alarm	Action when warning, shutdown, trips. Can be connected with annunciator externally. When "alarm mute" configurable input port is active, it can remove the alarm.
19	Louver Control	Action when genset starting and off when genset stopped completely.
20	Fuel Pump Control	It is controlled by fuel pump of level sensor's limited threshold.
21	Heater Control	It is controlled by heating of temperature sensor's limited threshold.
22	Cooler Control	It is controlled by cooler of temperature sensor's limited threshold.
23	Oil Pre-supply Output	Action from "crank on" to "safety on".
24	Generator Excite	Output in start period. If there is no generator frequency during hi-speed running, output for 2 seconds again.
25	Pre-lubricate	Actions in period of pre-heating to safety run.
26	Remote Control Output	This port is controlled by communication (PC).
27	GSM Power Supply	It is used for supply power for GSM module(power off and reset GSM module when GSM fail to communication)
28	Reserved	
29	Close Gen Output	Control generator to take load.
30	Open Gen Output	Control generator to off load.
31	Reserved	
32	Reserved	
33	Start Relay	



34	Fuel Relay	Action when genset is starting and off when stop is completed.
35	Idle Control	Used for engine which has idles. Close before starting and open in warming up delay; Close during stopping idle mode and open when stop is completed.
36	Speed Raise Relay	Action in warming up delay.
37	Speed Drop Relay	Action between the period from “stop idle” to “failed to stop”.
38	Energize to Stop	Used for engines with ETS electromagnet. Close when stop idle is over and open when pre-set “ETS delay” is over.
39	Speed Drop Pulse	Active 0.1s when controller enters into stop idle, used for control part of ECU dropping to idle speed.
40	ECU Stop	Used for ECU engine and control its stop.
41	ECU Power Supply	Used for ECU engine and control its power.
42	Speed Raise Pulse	Active 0.1s when controller entered into warming up delay; used for control part of ECU raising to normal speed.
43	Crank Success	Close when detects a successful start signal.
44	Generator OK	Action when generator is normal.
45	Generator Load Available	Action in period of generator ok to hi-speed cooling.
46	Reserved	
47	Synchronizing	Action when controller is synchronizing.
48	Common Alarm	Action when genset common warning, common shutdown, common trips alarm.
49	Common Trip and Stop	Action when common trip and stop alarm.
50	Common Shutdown	Action when common shutdown alarm.
51	Common Trip	Action when common trips alarm without stopping.
52	Common Warning	Action when common warning alarm.
53	Reserved	
54	Battery Over Voltage	Action when battery’s over voltage warning alarm.
55	Battery Under Voltage	Action when battery’s low voltage warning alarm.
56	Charge Alternator Failure	Action when charge failure warning alarms.
57	Reserved	
58	Reserved	
59	Reserved	
60	ECU Warning	Indicate ECU sends a warning signal.
61	ECU Shutdown	Indicate ECU sends a shutdown signal.
62	ECU Communication Failure	Indicate controller not communicates with ECU.
63	PWM Voltage Raise	When output type of AVR set as “Relay output”, controller adjust voltage and reactive power via “Sync Raise Volt” and “Sync Drop Volt”
64	PWM Voltage Drop	
65	PWM Speed Raise	When output type of GOV set as “Relay output”, controller adjust speed and power via “Sync Raise Speed” and “Sync Drop Speed”
66	PWM Speed Drop	
67	Reserved	
68	Reserved	
69	Digital Input 1 Active	Action when input port 1 is active
70	Digital Input 2 Active	Action when input port 2 is active
71	Digital Input 3 Active	Action when input port 3 is active



72	Digital Input 4 Active	Action when input port 4 is active
73	Digital Input 5 Active	Action when input port 5 is active
74	Digital Input 6 Active	Action when input port 6 is active
75	Digital Input 7 Active	Action when input port 7 is active
76	Digital Input 8 Active	Action when input port 8 is active
77~80	Reserved	
81~96	Extend Digital Input 1-16 Active	Action when extension digital input ports 1-16 are active
97~98	Reserved	
99	Emergency Stop	Action when emergency stop alarm.
100	Fail To Start	Action when failed start alarm.
101	Fail To Stop	Action when failed stop alarm.
102	Under Speed Warn	Action when under speed alarm.
103	Under Speed Shutdown	Action when under speed shuts down.
104	Over Speed Warn	Action when over speed warn.
105	Over Speed Shutdown	Action when over speed shutdown alarm.
106	Reserved	
107	Reserved	
108	Reserved	
109	Gen Over Freq. Warn	Action when generator over frequency warning.
110	Gen over Freq. Shutdown	Action when generator over frequency shutdown alarm.
111	Gen Over Volt Warn	Action when generator over voltage warning.
112	Gen Over Volt Shutdown	Action when generator over voltage shutdown.
113	Gen Under Freq. Warn	Action when generator low frequency warning.
114	Gen Under Freq. Shutdown	Action when generator low frequency shutdown.
115	Gen Under Volt. Warn	Action when generator low voltage warning.
116	Gen Under Volt. Shutdown	Action when generator low voltage shutdown.
117	Gen Loss of Phase	Action when generator loss phase.
118	Gen Phase Sequence Wrong	Action when generator reverse phase.
119	Reserved	
120	Over Power Alarm	Action when controller detects generator have over power.
121	Reserved	
122	Generator Reverse Power	Action when controller detects generator have reverse power.
123	Over Current Alarm	Action when over current.
124~133	Reserved	
134	NEL1 Trip	
135	NEL2 Trip	
136	NEL3 Trip	
137~138	Reserved	
139	High Temp Warn	Action when hi-temperature warning.
140	Low Temp Warn	Action when low temperature warning.
141	High Temp Shutdown	Action when hi-temperature Shutdown alarm.
142	Reserved	
143	Low Oil Pressure Warn	Action when low oil pressure warning.
144	Low Oil Pressure Shutdown	Action when low oil pressure shutdown.
145	Oil Pressure Open Circuit	Action when oil pressure sensor is open circuit.



146	Reserved	
147	Low Fuel Level	Action when controller has low oil level alarm.
148	Reserved	
149	Reserved	
150	Flexible Sensor 1 High Warn	
151	Flexible Sensor 1 Low Warn	
152	Flexible Sensor 1 High Shut	
153	Flexible Sensor 1 Low Shut	
154	Flexible Sensor 2 High Warn	
155	Flexible Sensor 2 Low Warn	
156	Flexible Sensor 2 High Shut	
157	Flexible Sensor 2 Low Shut	
158~161	Reserved	
162	Expand 1 Sensor 15 High Shutdown	
163	Expand 1 Sensor 15 High Warn	
164	Expand 1 Sensor 15 Low Shutdown	
165	Expand 1 Sensor 15 Low Warn	
166_201	Expand 1 Sensor 16-24	
202~229	Reserved	
230	Stop Mode	Action when system in stop mode.
231	Manual Mode	Action when system in Manual mode.
232	Reserved	
233	Auto Mode	Action when system in Auto mode.
234	Generator load	
235	Mains Load	
236~239	Reserved	
240~279	PLC Flag1~40	Action when PLC marked as 1
280~299	Reserved	

7.2.1 DEFINED PERIOD OUTPUT

Defined Period output is composed by 2 parts, period output S1 and condition output S2.



While S1 and S2 are **TRUE** synchronously, **OUTPUT**;

While S1 or S2 is **FALSE**, **NOT OUTPUT**.

Period output S1 can set generator's one or more period output freely, can set the delayed time and output time after enter into period.

Condition output S2; can set as any conditions in output ports.

NOTE: when delay time and output time both are 0 in period output S1, it is **TRUE** in this period.

Example,

Output period: start

Delay output time: 2s

Output time: 3s

Condition output contents: output port 1 is active

Close when condition output active/inactive: close when active (disconnect when inactive);

Output port 1 active, after enter "starts time" and delay 2s, this defined period output is outputting, after 3s, stop outputting;

Output port 1 inactive, defined output period is not outputting.

7.2.2 DEFINED COMBINATION OUTPUT

Defined combination output is composed by 3 parts, condition output S1 or S2 and condition output S3.

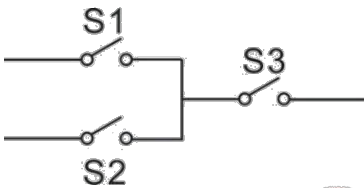

S1 or S2 is **TRUE**, while S3 is **TRUE**, Defined combination output is outputting;

S1 and S2 are **FALSE**, or S3 is **FALSE**, Defined combination output is not outputting.

NOTE: S1, S2, S3 can be set as any contents except for "defined combination output" in the output setting.

NOTE: 3 parts of defined combination output (S1, S2, S3) couldn't include or recursively include themselves.

Example,

Contents of probably condition output S1: Input port 1 is active;

Close when probably condition output S1 is active /inactive: close when active (disconnect when inactive);

Contents of probably condition output S2, input port 2 is active;

Close when probably condition output S2 is active /inactive: close when active (disconnect when inactive);

Contents of probably condition output S3: Input port 3 is active;



Close when probably condition output S3 is active /inactive: close when active (disconnect when inactive);

When input port 1 active or input port 2 active, if input port 3 is active, Defined combination output is outputting; If input port 3 inactive, Defined combination output is not outputting;

When input port 1 inactive and input port 2 inactive, whatever input port 3 is active or not, Defined combination output is not outputting.

7.3 DEFINED CONTENTS OF PROGRAMMABLE INPUT PORTS (ALL ACTIVE WHEN CONNECT TO GRAND (B~))

Form 3

No.	Type	Description
0	Users Configured	Including following functions, Indication: indicate only, not warning or shutdown. Warning: warn only, not shutdown. Shutdown: alarm and shutdown immediately Trip and stop: alarm, generator unloads and shutdown after hi-speed cooling Trip: alarm, generator unloads but not shutdown. Never: input inactive. Always: input is active all the time. From crank: detecting as soon as start. From safety on: detecting after safety on run delay.
1	Reserved	
2	Alarm Mute	Can prohibit "Audible Alarm" output when input is active.
3	Alarm Reset	Can reset shutdown alarm and trip alarm when input is active.
4	60HZ Active	Use for CANBUS engine and it is 60Hz when input is active.
5	Lamp Test	All LED indicators are illuminating when input is active.
6	Panel Lock	All buttons in panel is inactive except  and there is  in the left of first row in LCD when input is active.
7	Reserved	
8	Idle Speed Active	Under voltage/frequency/speed protection is inactive.
9	Auto Stop Inhibit	In Auto mode, during generator normal running, when input is active, prohibit generator shutdown automatically.
10	Auto Start Inhibit	In Auto mode, prohibit generator start automatically when input is active.
11	Scheduled Run Inhibit	In Auto mode, prohibit fixed timing start genset when input is active.
12	Reserved	
13	Gen Closed Auxiliary	Connect generator loading switch's Aux. Point.
14	Gen Load Inhibit	Prohibit genset switch on when input is active.
15	Reserved	
16	Reserved	
17	Auto Mode Lock	When input is active, controller enters into Auto mode; mode selection keys in the panel are inactive.
18	Auto Mode Inhibit	When input is active, controller won't work under Auto mode key and simulate auto key input does not work.
19	Static Parallel	
20	Black Start	
21	Alarm Stop Inhibit	All shutdown alarms are prohibited except emergence stop.(Means battle mode or override mode)
22	Aux Instrument Mode	All outputs are prohibited in this mode.
23	Non-parallel Mode	
24	Reset Maintenance	Controller will set maintenance time and date as default when input is



	Alarm	active.
25	Reserved	
26	High Temp Shut	Connected sensor digital input.
27	Low Oil Pressure Shut	Connected sensor digital input.
28	Remote Start (On Load)	In Auto mode, when input is active, genset can be started and with load after genset running normal; when input is inactive, genset will stop automatically.
29	Remote Start (Off Load)	In Auto mode, when input is active, genset can be started and without load after genset running normal; when input is inactive, genset will stop automatically.
30	Manual Start Auxiliary	In Auto mode, when input is active, genset will start automatically; when input is inactive, genset will stop automatically
31	Remote Start (On Demand)	
32	Reserved	
33	Simulate Stop Button	An external button can be connected and pressed as the simulate panel key.
34	Simulate Manual Button	
35	Reserved	
36	Simulate Auto Button	An external button can be connected and pressed as the simulate panel key.
37	Simulate Start Button	
38	Simulate Gen Load Button	This is simulating generator switch close button.
39	Simulate Mains Load Button	This is simulating generator switch open button.
40	NEL Manual Trip	
41	NEL Manual Reconnection	
42	Power Management Mode	
43	Mains Parallel Mode	
44	First Priority	
45	Reserved	
46	Reserved	
47	Configuration 1	Users can set different parameters to make it easy to select current configuration via input port.
48	Configuration 2	
49	Configuration 3	
50	Balance Test	
51	Speed Raise	
52	Speed Drop	
53	Voltage Raise	
54	Voltage Drop	
55	Reserved	



7.4 SELECTION OF SENSORS

Form4

No.		Description	Remark
1	Temperature Sensor	0 Not used 1 Custom Resistance Curve 2 Custom 4-20mA curve 3 VDO 4 CURTIS 5 VOLVO-EC 6 DATCON 7 SGX 8 SGD 9 SGH 10 PT100 11 SUSUKI 12 PRO 13-15 Reserved	Defined resistance's range is 0~6kΩ, default is SGX sensor.
2	Pressure Sensor	0 Not used 1 Custom Res Curve 2 Custom 4-20mA curve 3 VDO 10Bar 4 CURTIS 5 VOLVO-EC 6 DATCON 10Bar 7 SGX 8 SGD 9 SGH 10 VDO 5Bar 11 DATCON 5Bar 12 DATCON 7Bar 13 SUSUKI 14 PRO 15 Reserved	Defined resistance's range is 0~6kΩ, default is SGX sensor.
3	Oil Level Sensor	0 Not used 1 Custom Resistance Curve 2 Custom 4-20mA curve 3 SGD 4 SGH 5~15 Reserved	Defined resistance's range is 0~6kΩ, default is SGH sensor.

▲NOTE: User should make special declare when order controller if your genset equip with sensor of 4~20mA.

7.5 CONDITIONS OF CRANK DINSCONNECT SELECTION

No.	Setting Contents
0	Gen frequency
1	Speed sensor
2	Speed sensor + Gen frequency
3	Oil pressure
4	Oil pressure + Gen frequency
5	Oil pressure + Speed sensor
6	Oil pressure + Speed sensor + Gen frequency

△NOTE:

- a) There are 3 conditions to make starter disconnected with engine, that is, speed sensor, generator frequency and engine oil pressure. They all can be used separately. We recommend that engine oil pressure should be using with speed sensor and generator frequency together, in order to make the starter motor is separated with engine immediately and can check crank disconnect exactly.
- b) Speed sensor is the magnetic equipment which be installed in starter for detecting flywheel teeth.
- c) When set as speed sensor, must ensure that the number of flywheel teeth is as same as setting, otherwise, “over speed stop” or “under speed stop” may be caused.
- d) If genset without speed sensor please don't select corresponding items, otherwise, “start fail” or “loss speed signal” maybe caused.
- e) If genset without oil pressure sensor, please don't select corresponding items.
- f) If not select generator frequency in crank disconnect setting, controller will not collect and display the relative power quantity (can be used in water pump set); if not select speed sensor in crank disconnect setting, the rotating speed displayed in controller is calculated by generator frequency and number of poles.

8 PARAMETERS SETTING

⚠CAUTION: Please change the controller parameters when generator is in standby mode only (e. g. Start conditions selection, configurable input, configurable output, various delay), otherwise, alarming to stop and other abnormal conditions may happen.

⚠NOTE:

- 1) Maximum set value must over minimum set value in case that the condition of too high as well as too low will happen.
- 2) When setting the warning alarm, please set the correct return value; otherwise, maybe there is abnormal alarm. When setting the maximum value, the return value must less than setting; when setting the minimum value, the return value must over setting.
- 3) Please set the generator frequency value as low as possible when cranking, in order to make the starter be separated quickly as soon as crank disconnect.
- 4) Configurable input could not be set as same items; otherwise, there are abnormal functions. However, the configurable output can be set as same items.

9 SENSORS SETTING

- When reselect sensors, the sensor curve will be transferred into the standard value. For example, if temperature sensor is SGX (120°C resistor type), its sensor curve is SGX (120°C resistor type); if select the SGD (120°C resistor type), the temperature sensor curve is SGD curve.
- When there is difference between standard sensor curves and using sensor, user can adjust it in “curve type”.
- When input the sensor curve, X value (resistor) must be input from small to large, otherwise, mistake occurs.
- If select sensor type is set as “none”, sensor curve is not working.
- If corresponding sensor has alarm switch only, user must set this sensor as “none”, otherwise, maybe there is shutdown or warning.
- The headmost or backmost values in the vertical coordinates can be set as same as below,

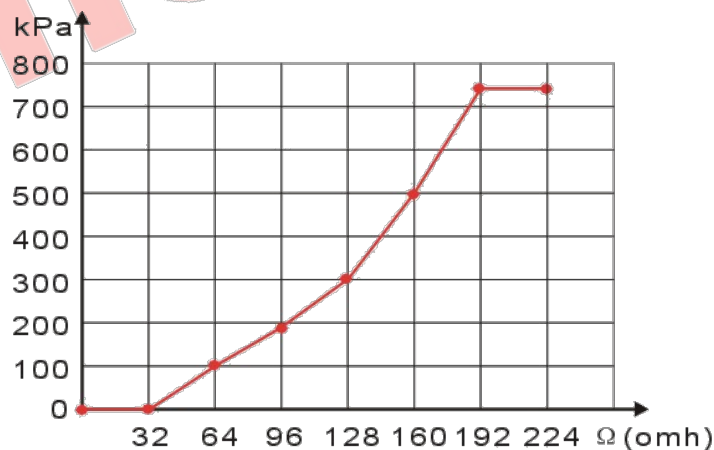

Normal Pressure Unit Conversion Form

	pa	kgf/cm ²	bar	psi
1Pa	1	1.02x10 ⁻⁵	1x10 ⁻⁵	1.45x10 ⁻⁴
1kgf/cm ²	9.8x10 ⁴	1	0.98	14.2
1bar	1x10 ⁵	1.02	1	14.5
1psi	6.89x10 ³	7.03x10 ⁻²	6.89x10 ⁻²	1

10 COMMISSIONING

10.1 STEP 1: SINGLE UNIT DEBUGGING

- 1) Check the parameter configuration of the controller;
- 2) Check the gen-set connections and MSC CAN connection lines between the units. (E.g. if 3 generators are correctly connected, SYNC screen will display Module Number: 3).
- 3) In manual mode, check if engine and generator data is normal;
- 4) In manual mode check if switch opens and closes normally;
- 5) In manual mode, after closing the breaker check if generator frequency can be adjusted to the rated frequency (e.g. set the rated frequency as 52Hz/48Hz);
- 6) In manual mode, after closing the breaker check if generator voltage can be adjusted to the rated voltage (e.g. set the rated voltage as 240V/220V);
- 7) Activate manual start on-load, check if power factor, active power and reactive power are normal; if negative value occurs, check generator voltage and current phase sequence, current transformer incoming line direction, current transformer secondary current dotted terminal;
- 8) In manual mode do performance tests according to the national standards.

▲NOTE: Please refer to *HGM9500 Parallel Plan List* for more information on **GOV** and **AVR** settings.

10.2 STEP 2: MANUAL PARALLEL OPERATION OFF-LOAD

- 1) Manually close parallel sets, check whether the units parallel synchronization is balanced or not and switching impulse current is too high or not;
- 2) During parallel operation off load, check that if there is with high circumfluence;
- 3) During parallel operation off load, check if the output of active and reactive power is equal to zero; if it is not, then check if there is power oscillation; if there is, adjust the gain and stability values of HGM8151 controller, or adjust engine GOV or generator AVR gain and stability potentiometer to avoid active and reactive power oscillation; output close to 0.

10.3 STEP 3: MANUAL PARALLEL OPERATION ON-LOAD

- 1) During manual parallel, perform on-load test and check if active and reactive power is evenly distributed between all the gensets;
- 2) During manual parallel, perform ramp on-load test to see if there is high overshoot or power oscillation during this period; if there is, regulate Load Ramp via PC software;
- 3) During manual parallel, perform ramp off-load test to see if gen-set breaker opens after reaching minimum set value (%);
- 4) During manual parallel, perform impact load test and damp load test to check if there is power oscillation.

10.4 STEP 4: AUTOMATIC PARALLEL OPERATION

When the controller is in auto status, if digital input “remote start on-load (on demand)” is active, it will carry out automatic parallel, start and stop operation. There are 3 ways of automatic parallel operation:

- 1) Start on demand: the module with the highest priority starts firstly. When load exceeds the pre-set start maximum percentage, the second according to the priority module will start the gen-set, synchronize and share load. When load falls lower than the preset minimum stop percentage, after stop delay the second module breaker will be open and the module will be cooled down and stopped.
- 2) Start all sets initially: all the modules start at the same time; the first module to reach load condition closes first; when other modules reach load condition, they synchronize one by one. After that the modules monitors the load. If load value falls below module pre-set shutdown minimum percentage, the module with lowest priority enters stop delay and then cools down and stops. If load exceeds the preset start maximum percentage, the generators that are at rest will all start again.
- 3) Balanced engine running time: Engine with the lowest total run time starts first. When the running gen-set total run time exceeds the other gen-set balanced running time, then the gen-set with the next lowest total run time starts (both “start on demand” or “start all sets initially” modes are possible); other gen-sets enter parallel operation after synchronizing. Opening breaker, unloading and stop is performed automatically. All the gen-sets are repeatedly started and stopped according to their total run time.

11 TYPICAL APPLICATION

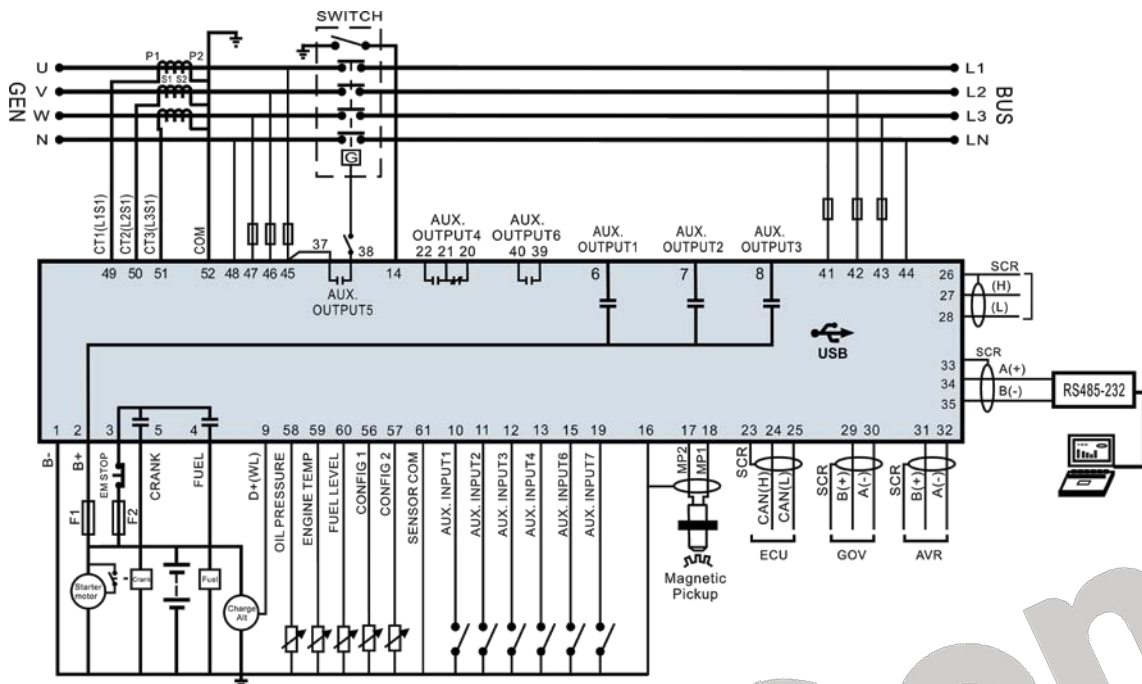

HGM8151 3P4W Typical Diagram

Note: Fuse F1: min. 2A; max. 20A. Fuse F2: max. 32A. Users should select suitable fuse depend on practical application.

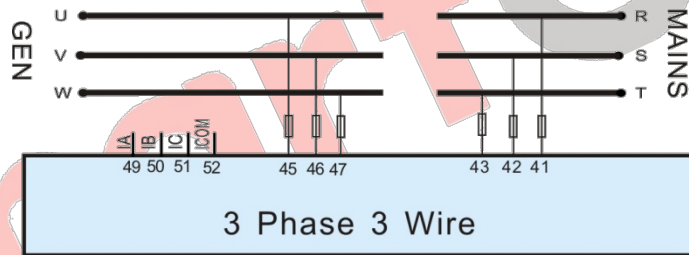

3 Phase 3 Wire

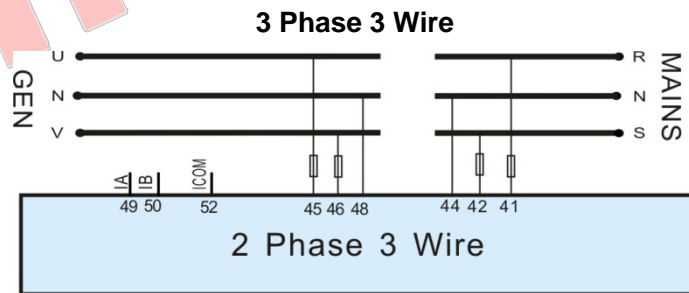

3 Phase 3 Wire

2 Phase 3 Wire

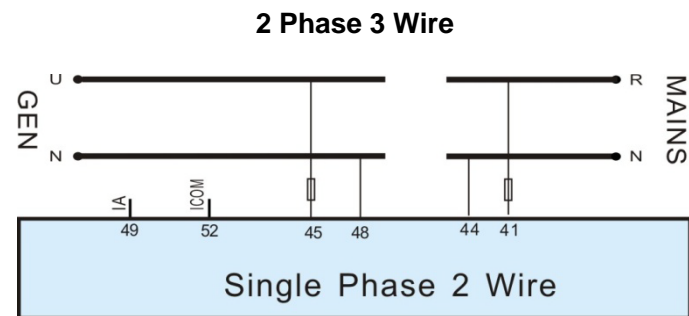

2 Phase 3 Wire

Single Phase 2 Wire

Single Phase 2 Wire

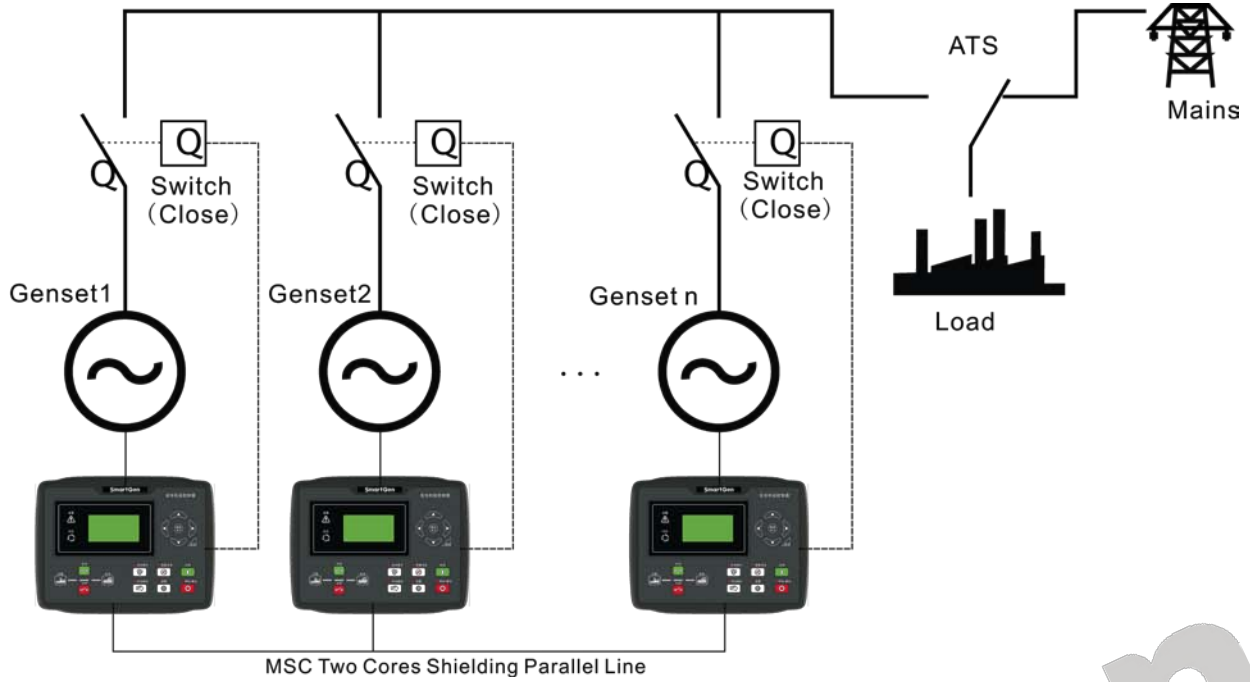

HGM8151 Multi-genset Parallel Application

Note: Mains parallel function for HGM8151 controller can be selected via configurable input port. In mains parallel mode, generator will run in parallel with mains and it will only be able to output a fixed amount of power. (Set load mode as Gen control mode).

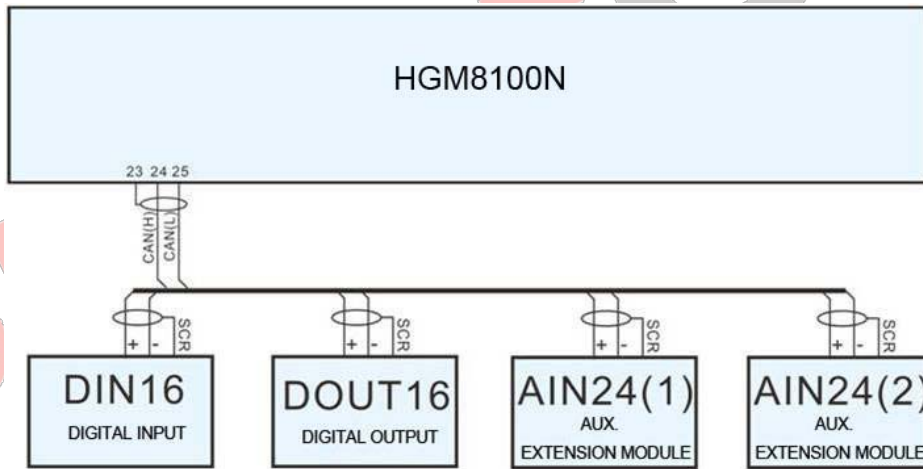

HGM8151 Extension Module Connection Diagram

12 POWER MANAGEMENT MODE

Power management mode can be selected via configurable input ports.

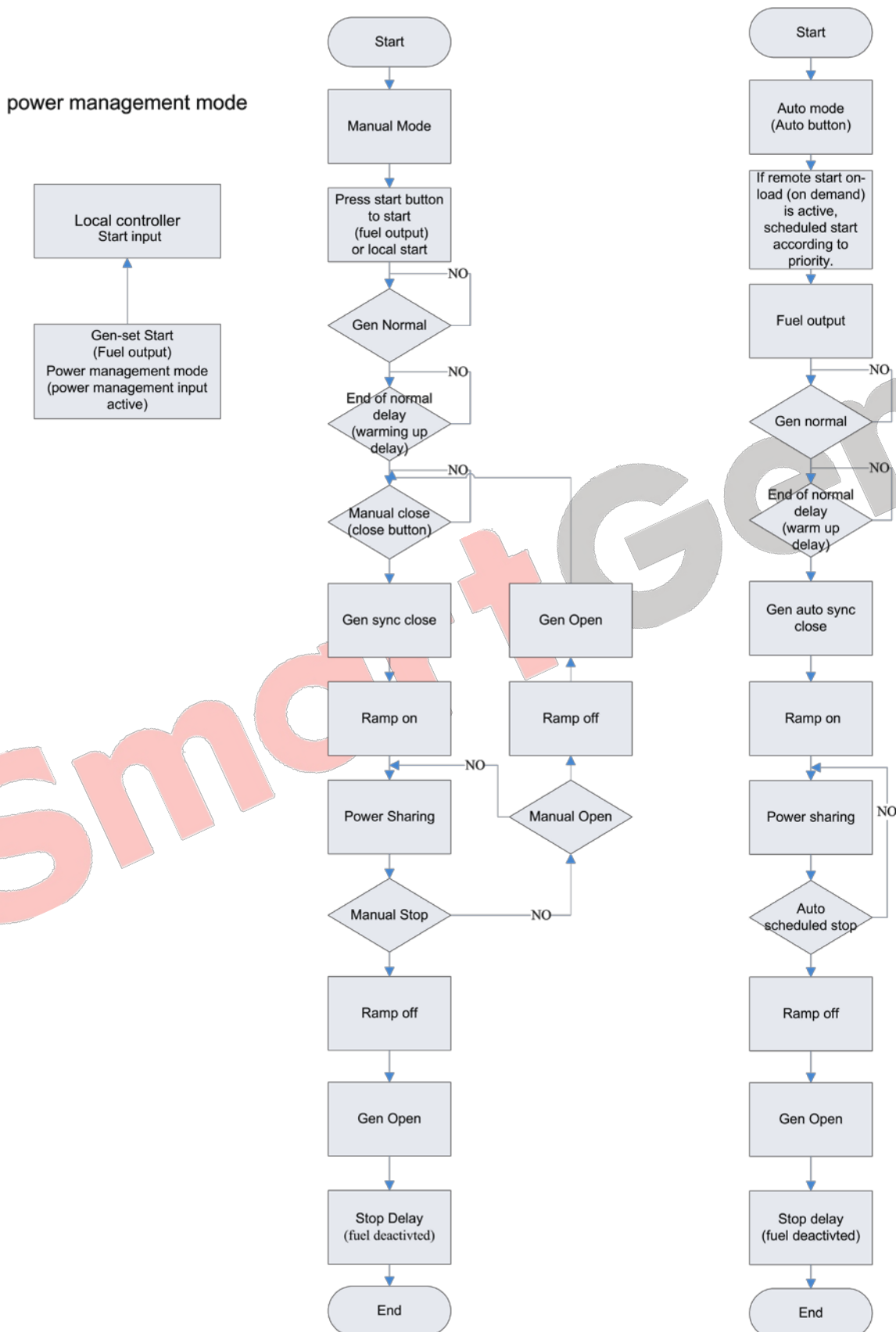

13 NEL TRIP ILLUSTRATION

Non-essential load ---- NEL for short.

The controller can control the NEL1, NEL2 and NEL3 to trip separately. The order of the essentiality is: NEL3 > NEL2 > NEL1

Auto trip:

— Auto Operation

- When NEL auto trip is enabled:

If the genset power has exceeded the NEL trip value, after the trip delay, NEL1 will trip the earliest, and then is NEL2, NEL3;

- When NEL auto reconnection is enabled:

If the genset power has fallen below the auto reconnection set value, after the auto reconnection delay, NEL3 will reconnection the earliest, and then is NEL2, NEL1;

t1: NEL Trip Delay
t2: Reconnection Delay

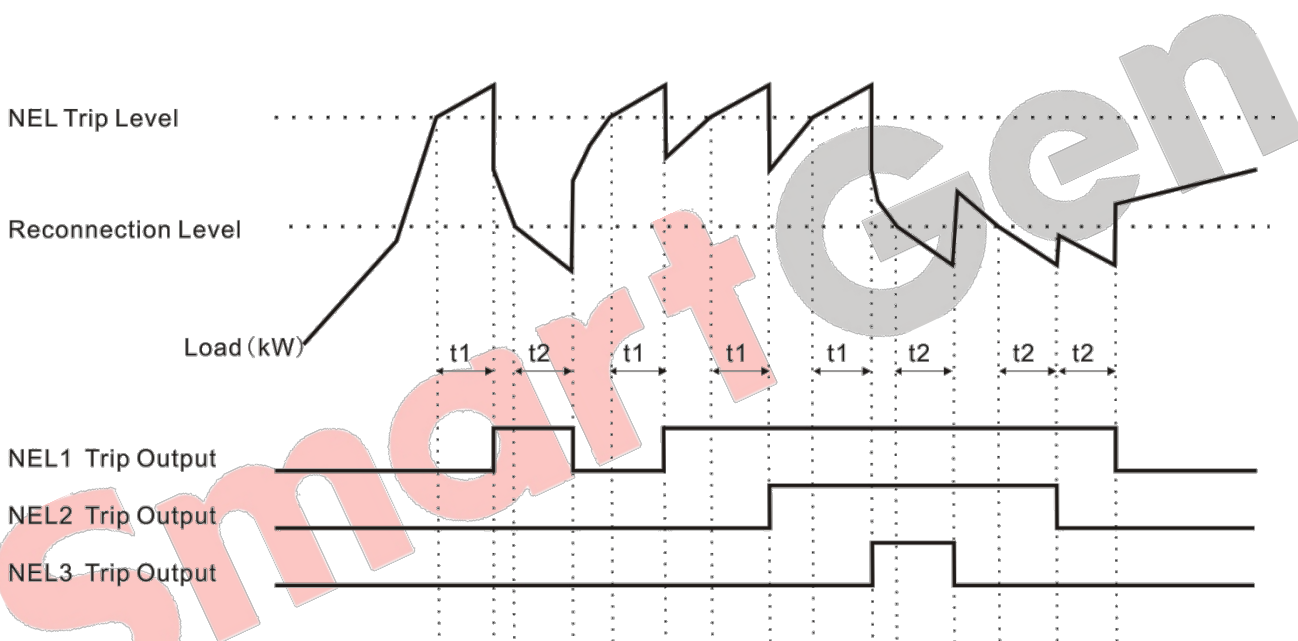

Manual Trip

- If NEL manual trip input is active (earthed falling edge is active), NEL1 will trip without delay; If NEL manual trip input is active again, NEL2 will trip; If NEL manual trip input is active the third time, NEL3 will trip. During this process, the controller do not detect if the genset power has exceeded the NEL trip value or not.
- If NEL manual reconnection input is active (earthed falling edge is active), NEL3 will reconnect without delay; If NEL manual reconnection input is active again, NEL2 will reconnect; If NEL manual reconnection input is active the third time, NEL1 will reconnect. During this process, the controller detects the genset power: if the genset power has fallen below the NEL reconnection value, then the input is active; if it doesn't, the input is deactivated.

▲Note: When auto trip and auto reconnection are enabled, manual trip is still active.

14 INSTALLATION

Controller is panel built-in design; it is fixed by clips when installed. The controller's overall dimensions and cutout dimensions for panel, please refers to as following,

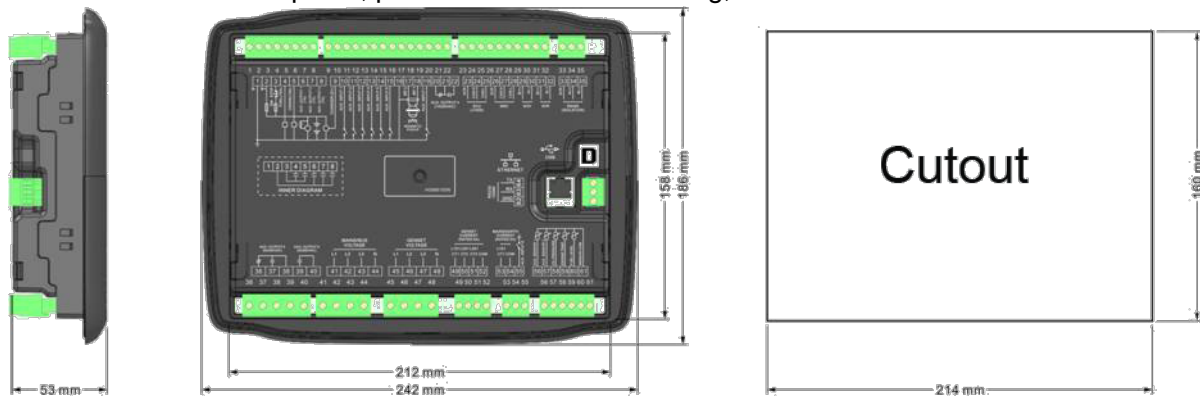

14.1 BATTERY VOLTAGE INPUT

HGM8151 controller can suit for widely range of battery voltage (8~35) VDC. Negative of battery must be connected with the shell of starter stable. The wire's diameter must be over 2.5mm^2 and which is connected to B+ and B- of controller power. If floating charge configured, please firstly connect output wires of charger to battery's positive and negative directly, then, connect wires from battery's positive and negative to controller's positive and negative input ports in order to prevent charge disturbing the controller's normal working.

14.2 SPEED SENSOR INPUT

Speed sensor is the magnetic equipment which be installed in starter and for detecting teeth of flywheel. Its connection wires to controller should apply for 2 cores shielding line. The shielding layer should connect to No. 16 terminal in controller while another side is hanging in air. The else two signal wires are connected to No.17 and No.18 terminals in controller. The output voltage of speed sensor should be within AC(1~24)V (effective value) during the full speed. AC12V is recommended (in rated speed). When install the speed sensor, let the sensor is spun to contacting flywheel first, then, port out 1/3 lap, and lock the nuts of sensor at last.

14.3 OUTPUT AND EXPAND RELAYS

All outputs of controller are relay contact output type. If need to expand the relays, please add freewheel diode to both ends of expand relay's coils (when coils of relay has DC current) or, increase resistance-capacitance return circuit (when coils of relay has AC current), in order to prevent disturbance to controller or others equipment.

14.4 AC INPUT

Current input of controller must be connected to outside current transformer. And the current transformer's secondary side current must be 5A. At the same time, the phases of current transformer and input voltage must correct. Otherwise, the current of collecting and active power maybe not correct.

NOTE: ICOM port must be connected to negative pole of battery.

WARNING! When there is load current, transformer's secondary side prohibit open circuit.

14.5 WITHSTAND VOLTAGE TEST

CAUTION! When controller had been installed in control panel, if need the high voltage test, please disconnect controller's all terminal connections, in order to prevent high voltage into controller and damage it.

15 GSM SHORT MESSAGE ALARM AND REMOTE CONTROL

15.1 GSM SHORT MESSAGE ALARM

When controller detects alarm, it will send short message to phone automatically.

▲NOTE: All alarms about shutdown, trip and stop and trip will be sent to the pre-set phone. Warnings are sent to the phone according to the pre-set.

15.2 GSM SHORT MESSAGE REMOTE CONTROL

Users send order message to GSM module, then controller will make actions according to this SMS order and pass back corresponding operations information. Controllers only execute the orders by pre-set.

SMS Orders List:

No.	SMS Orders	Pass back Information	Description
1	SMS GENSET	GENSET ALARM	When genset is stopping alarm
		SYSTEM IN STOP MODE GENSET AT REST	At rest status in stop mode
		SYSTEM IN MANUAL MODE GENSET AT REST	At rest status in manual mode
		SYSTEM IN AUTO MODE GENSET AT REST	At rest status in Auto mode
		SYSTEM IN STOP MODE GENSET IS RUNNING	Running status in stop mode
		SYSTEM IN MANUAL MODE GENSET IS RUNNING	Running status in manual mode
		SYSTEM IN AUTO MODE GENSET AT RUNNING	Running status in stop mode
2	SMS START	GENSET ALARM	Generator is shutdown alarm or trip alarm
		STOP MODE NOT START	Cannot start in stop mode
		SMS START OK	Start in manual mode
		AUTO MODE NOT START	Cannot start in auto mode
3	SMS STOP MODE	SMS STOP OK	Set as stop mode
4	SMS MANUAL MODE	SMS MANUAL MODE OK	Set as manual mode
5	SMS AUTO MODE	SMS AUTO MODE OK	Set as auto mode
6	SMS DETAIL	Pass back information can be set via controller software.	Gets details information of genset.
7	SMS INHIBIT START	INHIBIT START OK	Set as inhibit start
8	SMS PERMIT START	PERMIT START OK	Remove inhibit boot

▲NOTE: Its national and area's cods must be added. e.g. China: 861366666666.

▲NOTE: When sending orders, users need to follow SMS orders in above form and all the letters must be capital.

▲NOTE: Pass back information from SMS DETAIL including: working mode, mains voltage, generator voltage, load current, mains frequency, generator frequency, active power, apparent power, power factor, battery voltage, D+ voltage, water temperature, oil pressure, oil level, engine speed, total running time, genset status, and alarm status.

SmartGen

16 CONNECTIONS OF CONTROLLER WITH J1939 ENGINE

16.1 CUMMINS ISB/ISBE

Terminals of controller	Connector B	Remark
Fuel relay output	39	
Start relay output	-	Connect with starter coil directly
Auxiliary output port 1	Expand 30A relay, battery voltage of 01,07,12,13 is supplied by relay	ECU power Set configurable output 1 as "ECU power"

Terminals of controller	9 pins connector	Remark
CAN GND	SAE J1939 shield	CAN communication shielding line(connect with ECU terminal only)
CAN(H)	SAE J1939 signal	Impedance 120Ω connecting line is recommended.
CAN(L)	SAE J1939 return	Impedance 120Ω connecting line is recommended.

Engine type: Cummins ISB

16.2 CUMMINS QSL9

Suitable for CM850 engine control module

Terminals of controller	50 pins connector	Remark
Fuel relay output	39	
Start relay output	-	Connect to starter coil directly

Terminals of controller	9 pins connector	Remark
CAN GND	SAE J1939 shield-E	CAN communication shielding line(connect with ECU terminal only)
CAN(H)	SAE J1939 signal-C	Using impedance 120Ω connecting line
CAN(L)	SAE J1939 return-D	Using impedance 120Ω connecting line

Engine type: Cummins-CM850

16.3 CUMMINS QSM11(IMPORT)

It is suitable for CM570 engine control module. Engine type is QSM11 G1, QSM11 G2.

Terminals of controller	C1 connector	Remark
Fuel relay output	5&8	Outside expand relay, when fuel output, making port 5 and port 8 of C1 be connected
Start relay output	-	Connect to starter coil directly

Terminals of controller	3 pins data link connector	Remark
CAN GND	C	CAN communication shielding line(connect with ECU terminal only)
CAN(H)	A	Using impedance 120Ω connecting line
CAN(L)	B	Using impedance 120Ω connecting line

Engine type: Cummins ISB

16.4 CUMMINS QSX15-CM570

It is suitable for CM570 engine control module. Engine type is QSX15.

Terminals of controller	50 pins connector	Remark
Fuel relay output	38	Oil spout switch
Start relay output	-	Connect to starter coil directly

Terminals of controller	9 pins connector	Remark
CAN GND	SAE J1939 shield-E	CAN communication shielding line(connect with ECU terminal only)
CAN(H)	SAE J1939 signal-C	Using impedance 120Ω connecting line
CAN(L)	SAE J1939 return-D	Using impedance 120Ω connecting line

Engine type: Cummins QSX15-CM570

16.5 CUMMINS GCS-MODBUS

It is suitable for GCS engine control module. Use RS485-MODBUS to read information of engine.

Engine types are QSX15, QST30, QSK23/45/60/78 and so on.

Terminals of controller	D-SUB connector 06	Remark
Fuel relay output	5&8	Outside expand relay, when fuel output, making port 05 and 08 of the connector 06 be connected.
Start relay output	-	Connect to starter coil directly

Terminals of controller	D-SUB connector 06	Remark
RS485 GND	20	CAN communication shielding line(connect with ECU terminal only)
RS485+	21	Using impedance 120Ω connecting line
RS485-	18	Using impedance 120Ω connecting line

Engine type: Cummins QSK-MODBUS, Cummins QST-MODBUS, Cummins QSX-MODBUS

16.6 CUMMINS QSM11

Terminals of controller	OEM connector of engine	Remark
Fuel relay output	38	
Start relay output	-	Connect with starter coil directly
CAN GND	-	CAN communication shielding line(connect with controller's this terminal only)
CAN(H)	46	Using impedance 120Ω connecting line
CAN(L)	37	Using impedance 120Ω connecting line

Engine type: common J1939

16.7 CUMMINS QSZ13

Terminals of controller	OEM connector of engine	Remark
Fuel relay output	45	
Start relay output	-	Connect to starter coil directly
Programmable output 1	16&41	Setting to idle speed control, normally open output. Making 16 connect to 41 during high-speed running of controller via external expansion relay.
Programmable output 2	19&41	Setting to pulse raise speed control, normally open output. Making 19 connect with 41 for 0.1s during high-speed warming of controller via external expansion relay.
CAN GND	-	CAN communication shielding line(connect with controller's this terminal only)
CAN(H)	1	Using impedance 120Ω connecting line
CAN(L)	21	Using impedance 120Ω connecting line

Engine type: Common J1939
16.8 DETROIT DIESEL DDEC III / IV

Terminals of controller	CAN port of engine	Remark
Fuel relay output	Expand 30A relay, battery voltage of ECU is supplied by relay	
Start relay output	-	Connect to starter coil directly
CAN GND	-	CAN communication shielding line(connect with controller's terminal only)
CAN(H)	CAN(H)	Using impedance 120Ω connecting line
CAN(L)	CAN(L)	Using impedance 120Ω connecting line

Engine type: Common J1939
16.9 DEUTZ EMR2

Terminals of controller	F connector	Remark
Fuel relay output	Expand 30A relay, battery voltage of 14 is supplied by relay. Fuse is 16A	
Start relay output	-	Connect to starter coil directly
-	1	Connect to battery negative pole
CAN GND	-	CAN communication shielding line(connect with controller's terminal only)
CAN(H)	12	Impedance 120Ω connecting line is recommended.
CAN(L)	13	Impedance 120Ω connecting line is recommended.

Engine type: VolvoEDC4

16.10 JOHN DEERE

Terminals of controller	21 pins connector	Remark
Fuel relay output	G,J	
Start relay output	D	
CAN GND	-	CAN communication shielding line(connect with controller's terminal only)
CAN(H)	V	Using impedance 120Ω connecting line
CAN(L)	U	Using impedance 120Ω connecting line

Engine type: John Deere

16.11 MTU MDEC

Suitable for MTU engines, 2000 series, 4000series

Terminals of controller	X1 connector	Remark
Fuel relay output	BE1	
Start relay output	BE9	
CAN GND	E	CAN communication shielding line(connect with one terminal only)
CAN(H)	G	Using impedance 120Ω connecting line
CAN(L)	F	Using impedance 120Ω connecting line

Engine type: MTU-MDEC-303

16.12 MTU ADEC(SMART MODULE)

It is suitable for MTU engine with ADEC (ECU8) and SMART module.

Terminals of controller	ADEC (X1port)	Remark
Fuel relay output	X1 10	X1 Terminal 9 Connected to negative of battery
Start relay output	X1 34	X1 Terminal 33 Connected to negative of battery
Terminals of controller	SMART (X4 port)	Remark
CAN GND	X4 3	CAN communication shielding line(connect to controller's this terminal only)
CAN(H)	X4 1	Using impedance 120Ω connecting line
CAN(L)	X4 2	Using impedance 120Ω connecting line

Engine type: MTU-ADEC

16.13 MTU ADEC(SAM MODULE)

It is suitable for MTU engine with ADEC (ECU7) and SAM module.

Terminals of controller	ADEC (X1port)	Remark
Fuel relay output	X1 43	X1 Terminal 28 Connected to negative of battery
Start relay output	X1 37	X1 Terminal 22 Connected to negative of battery
Terminals of controller	SAM (X23 port)	Remark
CAN GND	X23 3	CAN communication shielding line(connect with controller's this terminal only)
CAN(H)	X23 2	Using impedance 120Ω connecting line
CAN(L)	X23 1	Using impedance 120Ω connecting line

Engine type: Common J1939

16.14 PERKINS

It is suitable for ADEM3/ ADEM4 engine control module. Engine type is 2306, 2506, 1106, and 2806.

Terminals of controller	Connector	Remark
Fuel relay output	1,10,15,33,34	
Start relay output	-	Connect to starter coil directly
CAN GND	-	CAN communication shielding line(connect with controller's terminal only)
CAN(H)	31	Using impedance 120Ω connecting line
CAN(L)	32	Using impedance 120Ω connecting line

Engine type: Perkins

16.15 SCANIA

It is suitable for S6 engine control module. Engine type is DC9, DC12, and DC16.

Terminals of controller	B1 connector	Remark
Fuel relay output	3	
Start relay output	-	Connect to starter coil directly
CAN GND	-	CAN communication shielding line(connect with controller's terminal only)
CAN(H)	9	Using impedance 120Ω connecting line
CAN(L)	10	Using impedance 120Ω connecting line

Engine type: Scania

16.16 VOLVO EDC3

Suitable engine control mode is TAD1240, TAD1241, and TAD1242.

Terminals of controller	"Stand alone" connector	Remark
Fuel relay output	H	
Start relay output	E	
programmable output 1	P	ECU power Configurable output 1, "ECU power"

Terminals of controller	"Data bus" connector	Remark
CAN GND	-	CAN communication shielding line(connect with controller's terminal only)
CAN(H)	1	Using impedance 120Ω connecting line
CAN(L)	2	Using impedance 120Ω connecting line

Engine type: Volvo

▲NOTE: When this engine type is selected, preheating time should be set to at least 3 seconds.

16.17 VOLVO EDC4

Suitable engine types are TD520, TAD520 (optional), TD720, TAD720 (optional), TAD721, TAD722, and TAD732.

Terminals of controller	Connector	Remark
Fuel relay output	Expanded 30A relay, and relay offers battery voltage for terminal14. Fuse is 16A	
Start relay output	-	Connect to starter coil directly
	1	Connected to negative of battery
CAN GND	-	CAN communication shielding line(connect with controller's terminal only)
CAN(H)	12	Using impedance 120Ω connecting line
CAN(L)	13	Using impedance 120Ω connecting line

Engine type: VolvoEDC4

16.18 VOLVO-EMS2

Volvo Engine types are TAD734, TAD940, TAD941, TAD1640, TAD1641, and TAD1642.

Terminals of controller	Engine's CAN port	Remark
programmable output 1	6	ECU stop Configurable output 1 "ECU stop"
Programmable output 2	5	ECU power Configurable output 2 "ECU power"
	3	Negative power
	4	Positive power
CAN GND	-	CAN communication shielding line(connect with controller's terminal only)
CAN(H)	1(Hi)	Using impedance 120Ω connecting line
CAN(L)	2(Lo)	Using impedance 120Ω connecting line

Engine type: Volvo-EMS2

▲NOTE: When this engine type is selected, preheating time should be set to at least 3 seconds.

16.19 YUCHAI

It is suitable for BOSCH common rail pump engine.

Terminals of controller	Engine 42 pins port	Remark
Fuel relay output	1.40	Connect to engine ignition lock
Start relay output	-	Connect to starter coil directly
CAN GND	-	CAN communication shielding line(connect with controller's this terminal only)
CAN(H)	1.35	Using impedance 120Ω connecting line
CAN(L)	1.34	Using impedance 120Ω connecting line

Battery	Engine 2 pins	Remark
Battery negative	1	Wire diameter 2.5mm ²
Battery positive	2	Wire diameter 2.5mm ²

Engine type: BOSCH
16.20 WEICHAH

It is suitable for Weichai BOSCH common rail pump engine.

Terminals of controller	Engine port	Remark
Fuel relay output	1.40	Connect to engine ignition lock
Start relay output	1.61	
CAN GND	-	CAN communication shielding line(connect to the controller at this end only)
CAN(H)	1.35	Using impedance 120Ω connecting line
CAN(L)	1.34	Using impedance 120Ω connecting line

Engine type: GTSC1

▲NOTE: If there is any question of connection between controller and ECU communication, please feel free to contact SmartGen's service.

SmartGen

17 ETHERNET INTERFACE

17.1 ETHERNET INTERFACE INTRODUCTION

ETHERNET port, used for controller monitoring, has two connection modes: network client mode and web server mode.

NOTE: After changing controller network parameters (e.g. IP address, sub network mask etc.) new settings will take effect only after the controller is restarted.

17.2 NETWORK CLIENT MODE

When the controller is used as network client, it can be monitored via network port using TCP ModBus protocol.

The procedure is the following:

- 1) Set IP address and sub network of the controller. The IP address must in the same network segment as the IP address of monitoring equipment (e.g. PC) e.g.: if monitoring equipment IP address is 192.168.0.16, controller IP can be 192.168.0.18, sub network mask 255.255.255.0
- 2) Connect the controller. It can be connected to the monitoring equipment directly using network cable or via switchboard.
- 3) The communication between the controller and monitoring equipment is carried out using TCP ModBus protocol.

NOTE: In this connection mode controller parameters can be set. SmartGen provides testing software for this connection mode. Communication protocol can be obtained from the SmartGen service

17.3 CONTROLLER AND NETWORK CABLE CONNECTION

Controller Internet Access:

No.	Name	Description
1	TX+	Tranceive Data+
2	TX-	Tranceive Data-
3	RX+	Receive Data+
4	NC	Not connected
5	NC	Not connected
6	RX-	Receive Data-
7	NC	Not connected
8	NC	Not connected

17.3.1 CONTROLLER CONNECT WITH PC WITH A LINE OF CABLE

For this connection crossover cable must be used.

Crossover cable: EIA/TIA 568A standard on one end and EIA/TIA 568B on the other end.

NOTE: If PC network port has Auto MDI/MDIX function, parallel cable can also be used.

17.3.2 CONTROLLER AND PC CONNECTION VIA SWITCHBOARD (OR ROUTER).

Parallel lines must be used.

Parallel cable: EIA/TIA 568A standard on both ends or EIA/TIA 568B standard on both ends.

NOTE: If switchboard (or router) network port has Auto MDI/MDIX function, crossover cable can also be used.

18 FAULT FINDING

Symptoms	Possible Solutions
Controller no response with power.	Check starting batteries; Check controller connection wirings; Check DC fuse.
Genset shutdown	Check the water/cylinder temperature is too high or not; Check the genset AC voltage; Check DC fuse.
Controller emergency stop	Check emergence stop button is correct or not; Check whether the starting battery positive be connected with the emergency stop input; Check whether the circuit is open.
Low oil pressure alarm after crank disconnect	Check the oil pressure sensor and its connections.
High water temperature alarm after crank disconnect	Check the temperature sensor and its connections.
Shutdown Alarm in running	Check related switch and its connections according to the information on LCD; Check programmable inputs.
Fail to Start	Check fuel oil circuit and its connections; Check starting batteries; Check speed sensor and its connections; Refer to engine manual.
Starter no response	Check starter connections; Check starting batteries.
Genset running while ATS not transfer	Check ATS; Check the connections between ATS and controllers.
RS485 communication is abnormal	Check connections; Check setting of COM port is correct or not; Check RS485's connections of A and B is reverse connect or not; Check RS485 transfer model whether damage or not; Check communication port of PC whether damage.
ECU communication failed	Check connections of CAN high and low polarity; Check if correctly connected of 120Ω resistor; Check if type of engine correct; Check if connections from controller to engine and setting of outputs correct.
ECU warning or stop	Get information from LCD of alarm page; If there is detailed alarm, check engine according to description. If not, please refer to engine manual according to SPN alarm code.